

MANUALS

Instructions and warnings **IE**
System manager



TGC

Boiler
managing thermoregulator



INDEX

1	General information.....	2	Instructions for use.....	4
1.1	Symbols used in the manual.....	2	2.1 Description of thermoregulator - TGC boiler manager fields and levels.....	4
1.2	Compliant use of the appliance.....	2	2.2 Setting parameters.....	6
1.3	Information to be provided to the user.....	2	2.3 Other possible settings.....	20
1.4	Safety warnings.....	3	2.4 Enter access code.....	20
			2.5 Display error codes on the TGC thermoregulator - cascade manager.....	21
			3 Quick guide.....	22

1 GENERAL INFORMATION

1.1 SYMBOLS USED IN THE MANUAL

When reading this manual, pay special attention to the parts marked with these symbols:



DANGER!
Serious danger to safety and life



ATTENTION!
Possibly dangerous situation for the product and environment



NOTE!
Tips for the user

1.2 COMPLIANT USE OF THE APPLIANCE



The appliance was built based on the current technical level and recognised technical safety rules.

Nevertheless, following improper use the safety and life of the user or other people may be exposed to danger, i.e. damage to the appliance or other objects.

The appliance is designed for operation in hot water circulating heating systems.

Any other use is considered improper.

Immergas will not be held liable for any damage resulting from improper use.

Any use in accordance with the envisioned purposes includes the strict observance of the instructions in this manual.

1.3 INFORMATION TO BE PROVIDED TO THE USER



The user must be instructed in the use and operation of his/her heating system, in particular:

- Deliver these instructions to the user, as well as the other documents relative to the appliance contained in the packaging in an envelope. **The user must keep this documentation safe so that it is available for future consultation.**
- Inform the user of the importance of aeration vents and the flue exhaust system, highlighting how essential they are and how it is strictly forbidden to change them.
- Inform the user on how to control the water pressure in the system as well as the operations required to restore it.
- Inform the user on how to correctly regulate the temperature, control units/thermostats and radiators in order to save energy.
- Remember it is compulsory to carry out regular maintenance on the system once a year and a combustion analysis every two years (as per national legislation).
- If the appliance is sold or transferred to another owner or if the owner moves, leaving the appliance behind, always ensure the manual accompanies the appliance so that it may be consulted by the new owner and/or installer.

The manufacturer will not be held liable in the case of damage to people, animals or property due to the failure to observe the instructions contained in this manual.

1.4 SAFETY WARNINGS



ATTENTION!

Installation, adjustment and maintenance of the appliance must be carried out by professionally qualified staff, in compliance with regulations and provisions in force, as incorrect installation can cause damage to people, animals and property, for which the manufacturer will not be held liable.



DANGER!

NEVER attempt to carry out maintenance or repairs on the boiler of your own initiative.

Any work must be carried out by professionally qualified Unical-authorized staff; we advise you to stipulate a maintenance contract. Poor or irregular maintenance can compromise the operational safety of the appliance and cause damage to people, animals and property for which the manufacturer will not be held liable.



Changes to parts connected to the appliance

Do not make changes to the following elements:

- to the boiler
- to the gas, air, water and power supply lines
- to the flue pipe, safety valve and exhaust pipe
- to the constructive elements that affect the operational safety of the appliance.



Smell of gas

In case of the smell of gas observe the following safety instructions:

- do not use electric switches
- do not smoke
- do not use the telephone
- shut off the gas cut-off valve
- aerate the room where the gas leak occurred
- notify the gas supply company or a specialised company.



Explosive and easily flammable substances

Do not use or deposit explosive or easily flammable materials (for ex. petrol, paints, paper) in the room where the appliance is installed.

2 INSTRUCTIONS FOR USE

2.1 DESCRIPTION OF THERMOREGULATOR - TGC BOILER MANAGER FIELDS AND LEVELS.

For more information refer to the "INSTRUCTIONS FOR USE" supplied with the TGC thermoregulator.

FIELDS.

General

Summary of a value selection

Controls test = for the technician on duty

Date/Time/Holidays = for the user

Display

Display of system values (for example sensor values and nominal values). It is not possible to make any changes here.

User

Summary of the setting values, which can be set by the user.

Time program

Summary of timed programmes for the heating circuits, the domestic water circuit and supplementary functions.

Expert

Summary of values that require specific notions (installer) in order to be set.

Levels accessed by technicians are protected by code numbers (damage or malfunctions must not be excluded).

Plant Expert

Summary of values sent by the element board (EB).

LEVELS.

The regulation values in the various fields are selected in control levels:

- SETUP
- HOT-WATER
- HTG CIRCUIT I
- HTG CIRCUIT II
- SOLAR / MF

Setup

All of the display and setting values, that refer to the heat generator or the entire system, i.e. that cannot be assigned to any user circuit.

Domestic hot water



All of the display and setting values, concerning the domestic water preparation system.

Heating circuit I/II

All of the display and setting values, referring to the respective user circuits.

Solar / MF

All of the display and setting values, concerning the production of solar energy and multifunctional relay settings.

	General	SERVICE DATE / TIME / HOLIDAY
Open the control door	 turn counter-clockwise ↺	
	 turn clockwise ↻	
Display		SETUP
		HOT-WATER
		HTG CIRCUIT I
		HTG CIRCUIT II
		SOLAR / MF
User		SETUP
		HOT-WATER
		HTG CIRCUIT I
		HTG CIRCUIT II
		SOLAR / MF
Time program		CIRCL TIME
		HOTW-PROG
		HTG-PROG I 
		etc
Expert		SETUP
		HOT-WATER
		HTG CIRCUIT I
		HTG CIRCUIT II
		SOLAR / MF
Plant Expert		SETUP

Parameter editing procedure

Use the navigation knob to select the FIELD



The modifiable parameter will be displayed ex.



Move to the next editable parameter using the navigation knob and repeat the procedure listed above.

Once you have reached the FIELD ex: DATE/TIME press the programming key



Change the value of the parameter with the navigation knob



Press the programming key, the red led will light up



Press this key to memorise the value of the parameter, (the led will switch off).





The first time the control door is opened after the system has been powered, the **SETUP** level will be displayed once; below is the list of the displayed parameters.



Set the parameters: ENGLISH, TIME, YEAR, MONTH, DAY.

PLANT SELECT must be left _
The remaining parameters are already set.



Attention:
the **FACTORY SET CONFIGURATION PARAMETERS** are listed below to avoid damage caused by incorrect use, refer to the manual "TGC System Manager INSTRUCTIONS FOR USE" supplied with the boiler.

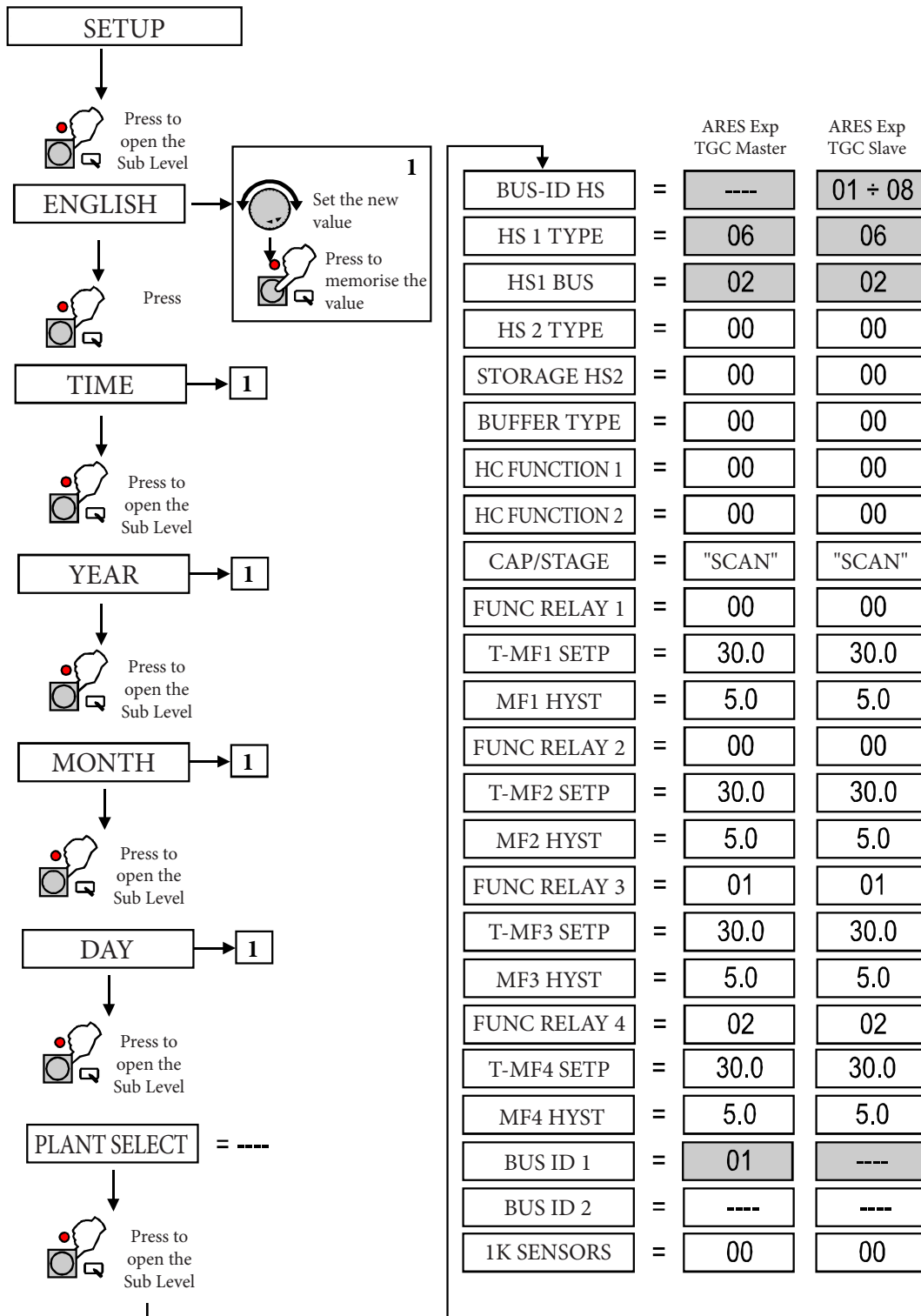

2.2 SETTING PARAMETERS



Field Description: **GENERAL**

The GENERAL field contains two fields:
DATE/TIME and SERVICE.

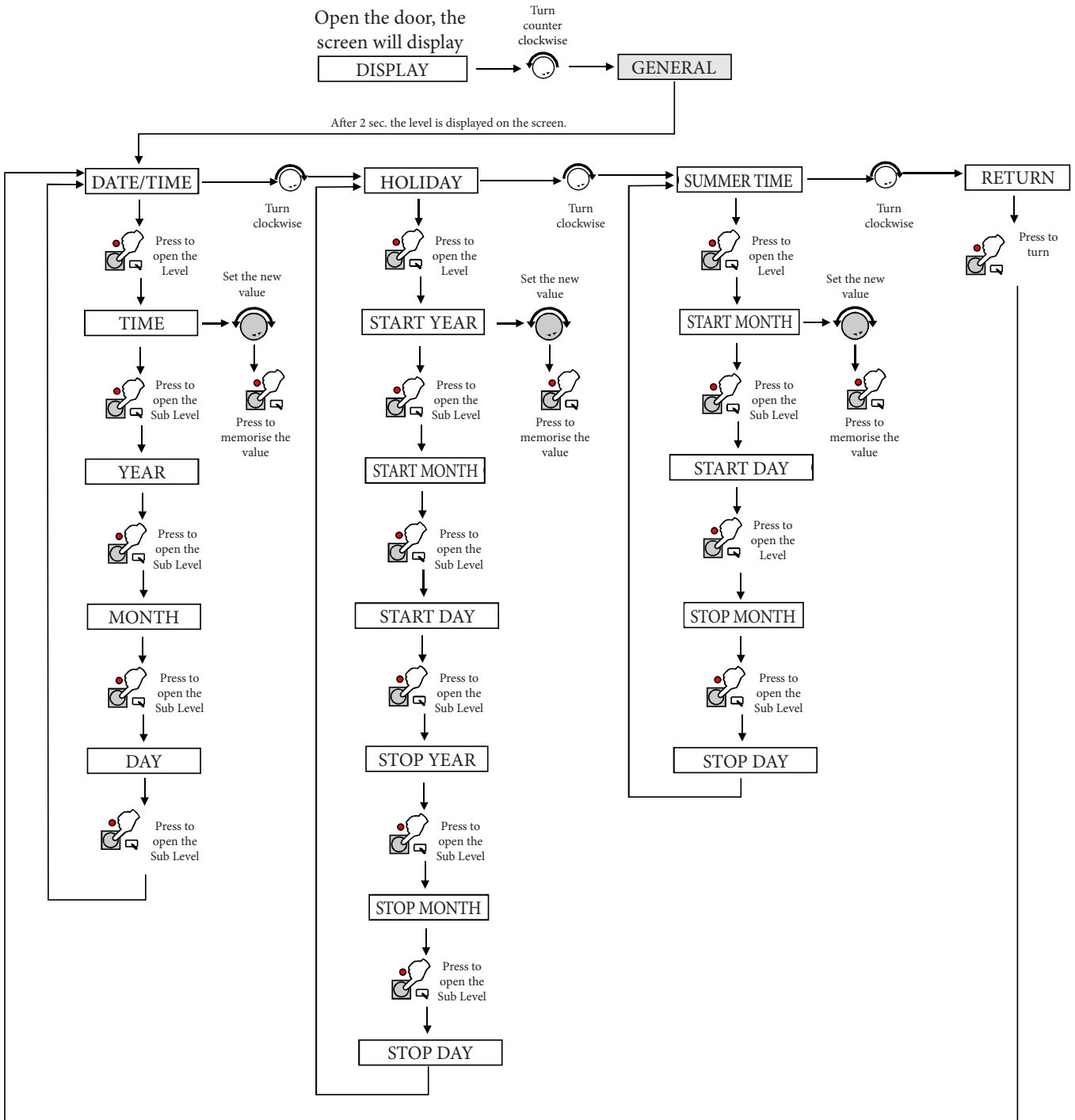

(*) Only by highlighting the SERVICE  symbol with the door closed.

GENERAL field.

LEVELS	DESCRIPTION	ADJUSTMENTS
DATE/TIME		
TIME	Time Adjustment	00:00 - 24:00
YEAR	Current Year Adjustment	XXXX
MONTH	Current Month Adjustment	01 - 12
DAY	Current Day Adjustment	01 - 31
HOLIDAYS		
START YEAR		XXXX
START MONTH	Adjust. the current month of the start of the holidays	01 - 12
START DAY	Adjust. the current day of the start of the holidays	01 - 31
STOP YEAR	Adjust. the current year of the end of the holidays	XXXX
STOP MONTH	Adjust. the current month of the end of the holidays	12 - 31
STOP DAY	Adjust. the current day of the end of the holidays	01 - 31
SUMMER TIME		
START MONTH	Adjust. the month for the start of DST	01 - 12
START DAY	Adjust. the first day for the start of DST	01 - 31
STOP MONTH	Adjust. the month for the end of standard time	01 - 12
STOP DAY	Adjust. the first month for the end of standard time	01 - 31

INSTRUCTIONS FOR USE

Field Description: SERVICE



NOTE: some menus are only visible when connected to the relative probe.
E.g.: HOT-WATER is only visible when storage tank probe is connected.

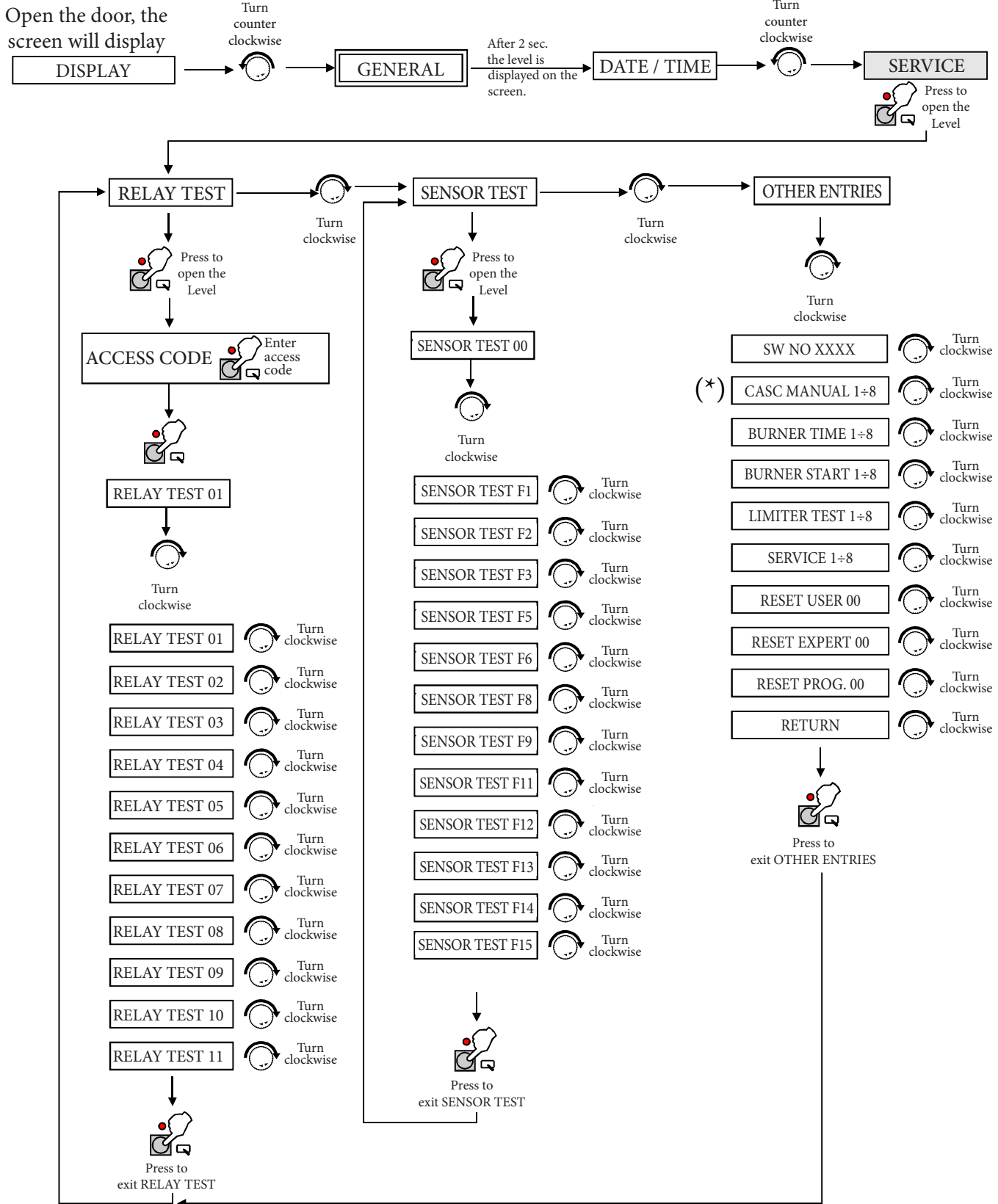

SERVICE field.

LEVELS	DESCRIPTION
RELAY TEST	
RELAY 00	No relay
RELAY 01	A1: Heating circuit pump 1
RELAY 02	A2: Heating circuit pump 2
RELAY 03	A3: Storage tank load pump
RELAY 04	A4: Mixing valve OPEN Heat. circ. 2
RELAY 05	A5: Mixing valve CLOSED Heat. circ. 2
RELAY 06	A6: GC 1 ON
RELAY 07	A7: GC 2 ON (2 levels: GC 1+2 (after 10 s) ON)
RELAY 08	A8: Mixer OPEN heating circuit 1/multifunction 1
RELAY 09	A9: Mixer CLOSED heating circuit 1/multifunction 2
RELAY 10	A10: Multifunction 3
RELAY 11	A11: Manifold pump / multifunction 4
SENSOR TEST	
F1	Below temperature buffer boiler
F2	
F3	Above temperature buffer boiler
F5	Heating circuit flow temperature 2
F6	Above hot water temperature
F8	Heat generator / Tank
F9	External temperature
F11	Heating circuit flow temperature 1 multifunction temp. saving 1
F12	Multifunction temp. saving below hot water temperature 2
F13	Manifold saving solid boiler 2 multifunction temp. saving 3
F14	Manifold 1 multifunction temp. saving temperature 4
F15	Heating circuit room temperature 2 saving Value measured by the light sensor 0-10V input voltage value saving
OTHER PARAMETERS	
SW NO XXX-XX	Software number with index
CASC MANUAL (1÷8)	Start single burner levels in cascade
BURNER TIME (1÷8)	Duration of burner operation for all levels
BURNER START (1÷8)	Burner ignition for all levels
LIMITER TEST (1÷8)	Safety limiter test with HG temp. display
SERVICE	Enter date / time for maintenance notification
RESET USER 00	(Never use these reset functions)
RESET EXP 00	(Never use these reset functions)
RESET PROG 00	(Never use these reset functions)
RETURN	

INSTRUCTIONS FOR USE

Field Description: DISPLAY



NOTE: some menus are only visible when connected to the relative probe.
E.g.: HOT-WATER is only visible when storage tank probe is connected.

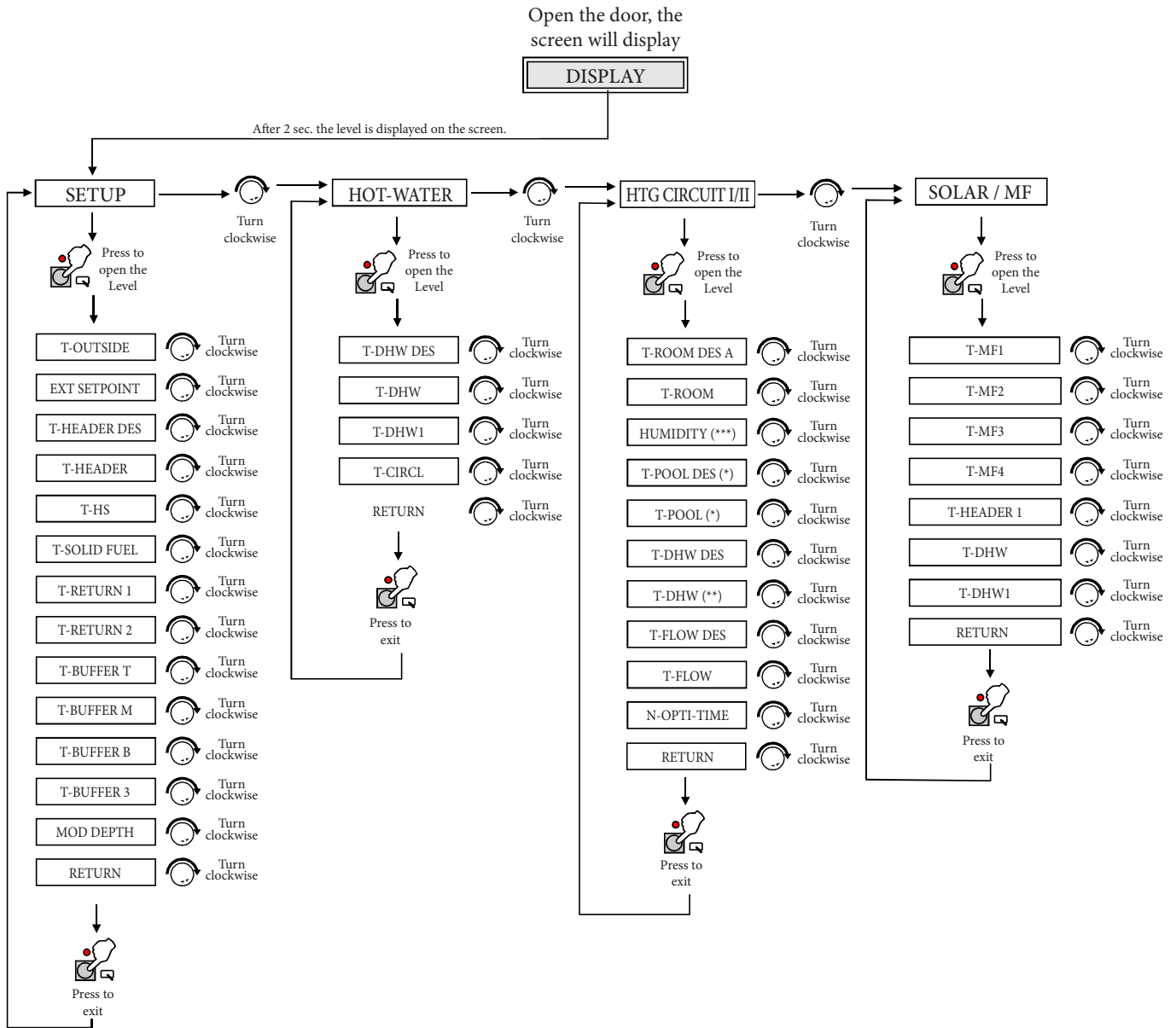

DISPLAY field.

LEVELS	DESCRIPTION
SETUP	
T-OUTSIDE	Outside temperature
EXT SETPOINT	External nominal value model (0-10 V)
T-HEADER DES	HG / Nominal tank value (cascade)
T-HEADER	HG / Tank temperature (cascade)
T-HS	Temperature level and HG status (HG1 - HG8)
T-SOLID FUEL	In HG 2 = boiler for solid fuels (A)
T-RETURN 1	Backflow temperature of HG1
T-RETURN 2	Backflow temperature of HG2
T-BUFFER T	Sample buffer temp
T-BUFFER M	HG loading zone buffer temp.
T-BUFFER B	Solar area buffer temp
T-STORAGE 3	Tank temperature 3 (ex: pool solar heating)
MOD DEPTH	Degree of modulation
RETURN	
HOT-WATER	
T-DHW DES	Current temperature of hot water sec. progr.
T-DHW	Current temperature of the domestic water
T-DHW I	Temperature of the DHW boiler in the bottom field
T-CIRCL	Circulation backflow temperature
RETURN	
HTG CIRCUIT 1 / 2	
T-ROOM DES A	Current nominal room temperature
T-ROOM	Current room temperature
HUMIDITY	Indication of the room humidity
T-POOL DES	Nominal pool temperature
T-POOL	Current pool temperature
T-DHW DES	Nominal domestic hot water temperature
T-DHW	Current domestic hot water temperature
T-FLOW DES	Current nominal flow temperature
T-FLOW	Current flow temperature
N-OPTI-TIME	Last requested period of heating
RETURN	
SOLAR / MF	
T-MF1	Sensor temperature MF1 (=F11)
T-MF2	Sensor temperature MF2 (=F12)
T-MF3	Sensor temperature MF3 (=F13)
T-MF4	Sensor temperature MF4 (=F14)
MF4	Manifold temperature 1
T-HEADER 1	Over hot water temperature
T-DHW I	Supply hot water temperature
RETURN	



Note: for detailed information refer to the instructions manual for use of the TGC thermoregulator.

INSTRUCTIONS FOR USE

Field Description: **USER**



NOTE: some menus are only visible when connected to the relative probe.
E.g.: HOT-WATER is only visible when storage tank probe is connected.

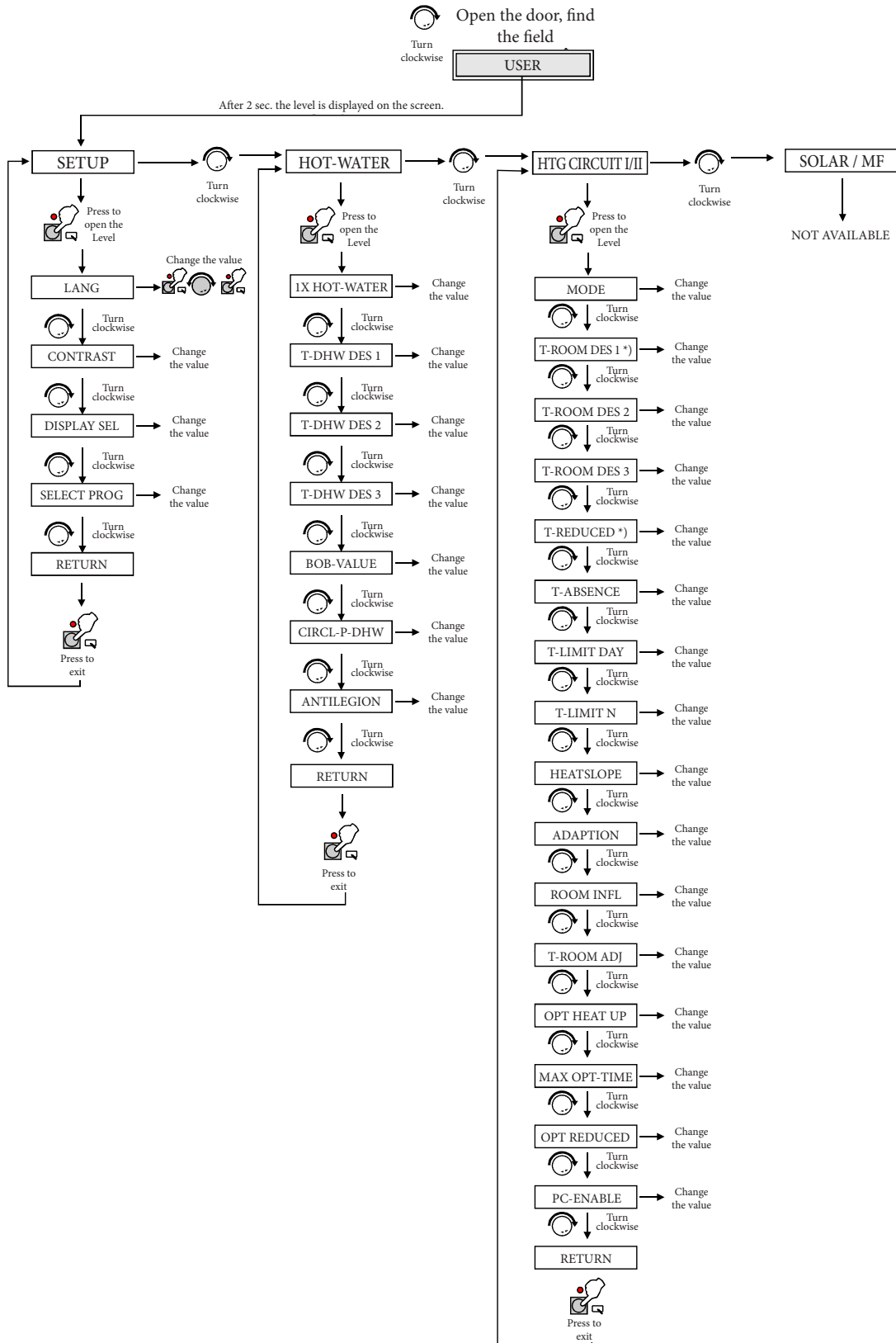

USER field.

LEVELS	DESCRIPTION	ADJUSTMENTS	
		Settings	Range
SETUP			
LANG	Choose Language	ENG	
CONTRAST	Display brightness setting	00	(-20) / (20)
DISPLAY SEL	Select a supplementary display	----	
SELECT PROG	Choose heating circuit 1 / heat. 2	01	(01 ÷ 02)
RETURN			
HOT-WATER			
1X DHW	Disable dhw times	00	(00 ÷ 01)
T-DHW 1	Hot water temp. 1 (time period 1)	60	(10 ÷ 70)
T-DHW 2	Hot water temp. 2 (time period 2)	60	(10 ÷ 70)
T-DHW 3	Hot water temp. 3 (time period 3)	60	(10 ÷ 70)
BOB VALUE	Solar integration energy savings function	0	(0 ÷ 70)
CIRCL-P-DHW	Enable storage tank recirc	0	(0 ÷ 1)
ANTILEGION	Enable anti-legionella function	0	(0 ÷ 1)
RETURN			
HTG CIRCUIT 1 / 2			
MODE	Operating mode setting	-----	
T-ROOM 1	Room temperature 1	20	(5 ÷ 40)
T-ROOM 2	Room temperature 2	20	(5 ÷ 40)
T-ROOM 3	Room temperature 3	20	(5 ÷ 40)
T-REDUCED	Required temperature for night-shift	10	(5 ÷ 40)
T-ABSENCE	Required temperature during holidays	15	(5 ÷ 40)
T-LIMIT DAY		19	(-5 ÷ 40)
T-LIMIT N		10	(-5 ÷ 40)
HEATSLOPE	External temp. compensation curve	1,20	(0 ÷ 3)
ADAPTION	Autom. heating curve setting	0	(0 ÷ 1)
ROOM INFL	Effect of room sensor	10	(0÷20)
T-ROOM ADJ	Thermometer calibration	0	(5K÷-5K)
OPT HEAT UP	Heat optimisation	0	(00 ÷ 02)
MAX OPT-TIME	Maximum heating optim. anticipation	2	(00 ÷ 03)
OPT REDUCED	Reduction optimisation	0	(00 ÷ 02)
PC-ENABLE	Enable PC	0000	(0000÷9999)
RETURN			
SOLAR / MF			
NOT AVAILABLE			

INSTRUCTIONS FOR USE

Field Description: TIME PROGRAM



NOTE: some menus are only visible when connected to the relative probe.
E.g.: HOT-WATER is only visible when storage tank probe is connected.



Open the door, find the field

TIME PROGRAM

After 2 sec. the level is displayed on the screen

CIRCL TIME



Turn clockwise

DHW PROGRAM (*)



Turn clockwise

HTG-PROG 1



Turn clockwise

HTG-PROG 2



Turn clockwise

HTG-PROG 1



Turn clockwise

HTG-PROG 2

Choose the day

MONDAY
TUESDAY
WEDNESDAY
THURSDAY
FRIDAY
SATURDAY
SUNDAY
MON - FRI
SAT - SUN
MON-SUN
RETURN

Choose on and off time

CIRCL TIME	Control time programme for the circulation pump
DHW PROGRAM (*)	Control time programme for hot water production
HTG-PROG 1	1. Heat programme for the first heat. circuit of the regulator
HTG-PROG 2	2. Heat programme for the first heat. circuit of the regulator
HTG-PROG 1	1. Heat programme for the second heat. circuit of the regulator
HTG-PROG 2	2. Heat programme for the second heat. circuit of the regulator

(*) Only enabled with parameter 1X DHW = 00



Setting the time on: -- : -- the time period is excluded.

Field Description: EXPERT

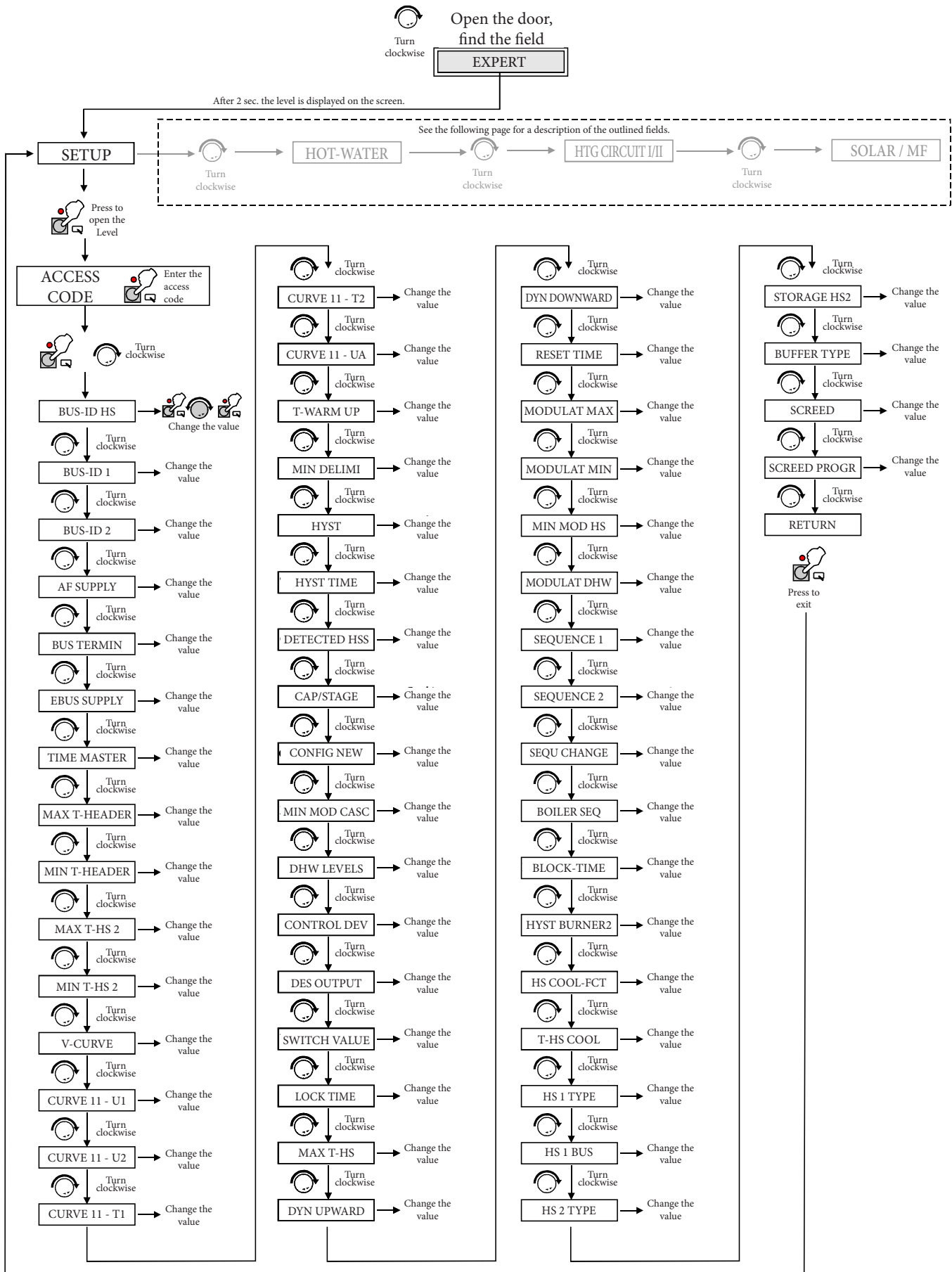

INSTRUCTIONS FOR USE

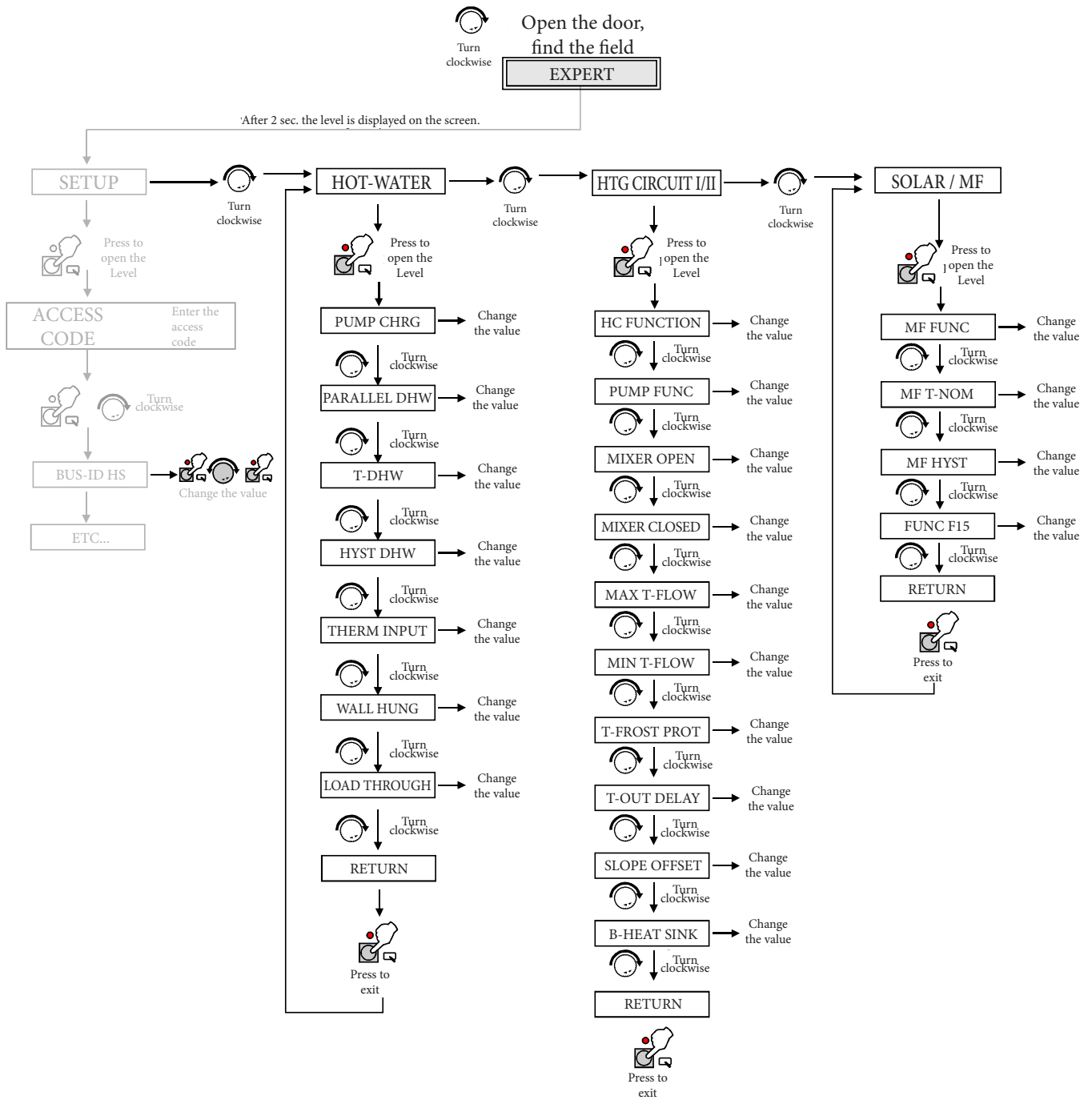

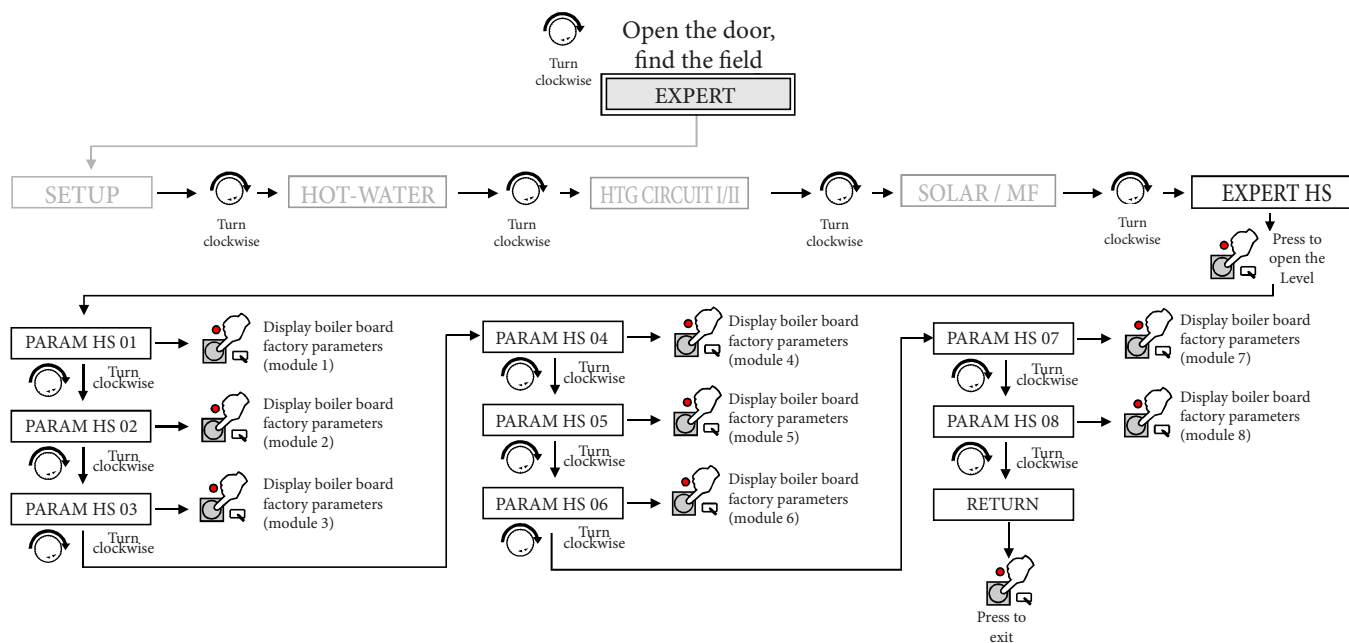

PARAM HS:
01 - 02 - 03 - 04 - 05 - 06 - 07 - 08 :

FAN MOD IGN
FAN MOD STBY
FAN MAX
FAN MIN
MAX DIFF PRO
MIN FLOW PRO
MIN FLOW RAT
BOIL HYS
BOIL SLP LIM
BOIL P VAL
BOIL I VAL
BOIL D VAL
PUMP OVERRUN
PUMP MIN MOD
CAP FLOW RATE
FAN P VAL
FAN I VAL
FAN SLP
FAN SLP POS
FAN SLP NEG
FAN START PW
FAN ADAPT
RESTARTS
SW NO
SW RWV

INSTRUCTIONS FOR USE

EXPERT field.

LEVELS	DESCRIPTION	ADJUSTMENTS	
		Setting	Range
SETUP			
BUS-ID HS	Address bus boiler only cascade of cascade	----	(01 ÷ 08)
BUS ID 1	Number of heating circuits	01	(01 ÷ 15)
BUS ID 2	Number of heating circuits	--	(01 ÷ 15)
AF SUPPLY	External probe power supply	01	(01 ÷ 15)
BUS TERMIN	Bus connection	01	(00 ÷ 01)
EBUS SUPPLY	Power supply for eBUS	01	(00 ÷ 01)
TIME MASTER	Time Masters	00	(01 ÷ 01)
MAX T-HEADER	Maximum manifold temperature	85°C	(30 ÷ 110)
MIN T-HEADER	Minimum manifold temperature	10°C	(10 ÷ 80)
MAX T-HS2	Maximum heating circuit temp. 2	85°C	(30 ÷ 110)
MIN T-HS2	Minimum heating circuit temp. 2	40°C	(10 ÷ 80)
V-CURVE	Select the voltage curve	11°C	(00 ÷ 11)
CURVE 11 - U1	Curve points 11 U1 maximum point	1 V	(0 V ÷ 10 V)
CURVE 11 - U2	Curve points 11 U2 maximum point	10 V	(0 V ÷ 10 V)
CURVE 11 - T1	Curve points 11 T1 minimum temperature	20°C	(0 ÷ 120)
CURVE 11 - T2	Curve points 11 T2 maximum temperature	85°C	(0 ÷ 120)
CURVE 11 - UA	Minimum voltage to turn on heating	2 V	(0 V ÷ 10 V)
T-WARM UP		35°C	(10 ÷ 85)
MIN DELIMI		0	(01 ÷ 03)
HYST		5	(2K ÷ 20K)
HYST TIME		0	(0 ÷ 30 min)
DETECTED HSS	Number of detected modules (only visual)	----	
CAP/STAGE	Module power levels	----	(0 ÷ 1000)
NEW CONFIG	New Ebus configuration	0	(00 ÷ 01)
MIN MOD CASC	Minimum cascade modulation	0	(00 ÷ 100)
DHW LEVELS	Number of levels for DHW	0	(00 ÷ 08)
CONTROL DEV	Difference between required temp. and actual temp. (visual)	0	(00 ÷ 08)
DES OUTPUT	System power request in % (visual)	----	(0 ÷ 100)
SWITCH VALUE			(-99 ÷ 99)
LOCK TIME	Actual residual value (visual)	0	
MAX T-HS	Maximum boiler temperature	90°C	(50 ÷ 110)
DYN UPWARD	Dynamic boiler switch on	100	(20 ÷ 500)
DYN DOWNWARD	Dynamic boiler switch off	80	(20 ÷ 500)
RESET TIME	Readjustment time for regulators	180	(5 ÷ 500)
MODULAT MAX	Maximum modulation	30	(5 ÷ 100)
MODULAT MIN	Minimum modulation	35	(10 ÷ 60)
MIN MOD HS		35	(0 ÷ 60)
MODULAT DHW		80	(40 ÷ 100)
SEQUENCE 1	Boiler succession 1 (visual)	---	12345678
SEQUENCE 2	Boiler succession 2 (visual)	---	87654321
SEQU CHANGE	Type of succession change	06	(01 ÷ 06)
BOILER SEQ	Interval between succession changes	200	(10 ÷ 800)
BLOCK-TIME	Minimum waiting time	01	(00 ÷ 30)
HYST BURNER2	Hysteresis 2 burner	2	(2 ÷ 20)
HS COOL-FCT	Boiler cooling function not used	0	(0 ÷ 1)
T-HS COOL	Initial cooling temperature not used	80	(50 ÷ 95)
HS 1 TYPE	Type of heat generator	06/02	(00 ÷ 06)
HS 1 BUS	Connection for heat generators	02/03	(00 ÷ 04)

LEVELS	DESCRIPTION	ADJUSTMENTS	
		Setting	Range
SETUP			
HS 2 TYPE	Type of generator	0	(00 ÷ 05)
STORAGE HS2	Thermoregulation for boiler 2	0	(00 ÷ 03)
BUFFER TYPE	Type of boiler for buffer heating	0	(00 ÷ 03)
SCREED	Turn on screed	0	(00 ÷ 01)
SCREED PROGR	Screed programme		
RETURN			
DOMESTIC HOT WATER			
PUMP CHRГ	Load pump block	0	(00 ÷ 01)
PARALLEL DHW	Parallel pump operation	0	(00 ÷ 03)
T-DHW	Nominal boiler temperature in DHW preparation	20	(00 ÷ 50)
HYST DHW	Hysteresis	5	(5 ÷ 30)
DHW FOLLOWUP	Pump inertia time	0	(00 ÷ 30)
THERM INPUT	Boiler with thermostat	0	(00 ÷ 01)
WALL HUNG	Actual boiler temperature + T DHW	0	(00 ÷ 01)
LOAD THROUGH	Enable continuous loading	0	(00 ÷ 01)
RETURN			
HTG CIRCUIT 1 / 2			
HC FUNCTION	Select functions for the heating circuit	0	(00 ÷ 04)
PUMP FUNC	Pump operation mode	02	(00 ÷ 03)
MIXER OPEN	Mixer opening dynamic	18	(5 ÷ 25)
MIXER CLOSED	Mixer closing dynamic	12	(5 ÷ 25)
MAX T-FLOW	Maximum flow temperature	80	(20 ÷ 110)
MIN T-FLOW	Minimum flow temperature	10	(10 ÷ 110)
T-FROST PROT	Frost temperature	0	(-15 ÷ -5)
T-OUT DELAY	External temperature delay	0	(0 ÷ 24)
SLOPE OFFSET	Heating curve distance	5	(0 ÷ 50)
B-HEAT SINK	Enable circuit	0	(00 ÷ 01)
RETURN			
SOLAR / MF			
MF FUNC	Multifunction relay (from 01 to 04)	--	(00 ÷ 26)
MF T-NOM	Nom. temp. for relay switching (from 01 to 04)	30	(30 ÷ 90)
MF HYST	Hysteresis	5	(2 ÷ 10)
FUNC. F15	Function sensor F15 (enable 10V input)	0	(00 ÷ 02)
RETURN			



The shaded parameters provided on the previous page change according to the type of generator and use, either cascade or single (parag. 2.1).



Note: for detailed information refer to the instructions manual for use of the TGC thermoregulator.

Some menus are only visible when the relative probe is connected.

2.3 OTHER POSSIBLE SETTINGS

Settings for heating circuits 1 \ 2

- Heating adjusted to fixed flow temperature (no external probe)
This provides the possibility of setting a fixed flow temperature on the selected circuit.

Expert Field → Heating circuit I/II → HC FUNCTION "01" (for more information see the chapter relative to the TGC thermoregulator manual).

Heating circuits temperature settings (Only after the function has been set).

User field → Heat. circuit I / II → T-FLOW DAY.

User field → Heat. circuit I / II → T-FLOW REDUC.

- Second storage tank. (Only after the function has been set)

This provides the possibility of using one of the heating zones for the preparation of a second storage tank.

Expert Field → Heating circuit I/II → HC FUNCTION "03" (for more information see the chapter relative to the TGC thermoregulator manual).

Second storage tank temperature settings

User field → Heat. circuit I / II → T-DHW.

- Pool regulator

This provides the possibility of using one of the heating zones to heat a pool.

Connect the pool probe to the connector (III 1+2).

Expert Field → Heating circuit I/II → HC FUNCTION "02" (for more information see the chapter relative to the TGC thermoregulator manual).

Pool temperature settings (Only after the function has been set)

User field → Heat. circuit I / II → T- POOL 1 / 2 / 3.

- Screed programme (under-floor systems)

Setting a screed-drying programme.

Expert Field → Setup → SCREED "01" (for more information see the chapter relative to the TGC thermoregulator manual).

Screed programme temperature settings

Expert Field → Setup → SCREED PROGR.

- 0 - 10 V signal usage

Enable 0 - 10 V input to control the climatic curve through external regulation. (conn. F15).

Expert Field → Solar / MF → FUNCTION F15 "01" (for more information see the chapter relative to the TGC thermoregulator manual).

- Curve and temperature settings with 0 - 10 V signal.

Expert Field → Setup → V-CURVE (from 0 to 11).

Expert Field → Setup → CURVE 11 - XX (Freely settable).

DHW circuit settings

- Parallel pump operation

The possibility of keeping the heating pumps running, even during DHW production.

Expert Field → Domestic Hot Water → PARALLEL DHW "00,01,02,03" (for more information see the chapter relative to the TGC thermoregulator manual).

- Using a storage tank thermostat (on/off)

Using a storage tank thermostat in place of the storage tank probe.

Expert Field → Domestic Hot Water → THERM INPUT "01" (for more information see the chapter relative to the TGC thermoregulator manual).

- Antilegionella

Enable antilegionella programme.

Expert Field → Domestic Hot Water → ANTILEGION "01" (for more information see the chapter relative to the TGC thermoregulator manual).

- Setting for solar manifold use

Use a PT 1000 probe as a manifold probe.

Expert Field → Solar / MF → FUNC RELAY 4 "23" (for more information see the chapter relative to the TGC thermoregulator manual).

N°	U1	U2	T1	T2	UA
0	2.0	10.0	0	90	2.0
1	2.5	0.3	38	80	5.0
2	2.5	0.3	38	75	5.0
3	2.5	0.3	38	45	5.0
4	4.0	0.1	20	85	5.0
5	4.0	0.1	20	75	5.0
6	4.0	0.1	20	55	5.0
7	4.0	0.1	30	87	5.0
8	4.0	0.1	38	87	5.0
9	4.0	0.1	38	73	5.0
10	4.0	0.1	38	53	5.0
11	4.0	0.1	20	90	5.0

Key:

U1 - Min volt

U2 - Max volt

T1 - Min temperature (min volt)

T2 - Max temperature (max volt)

UA - off

2.4 ENTER ACCESS CODE



Press the programming key to enter the access code.



NOTE: to change or view certain parameters it is necessary to enter the access code.

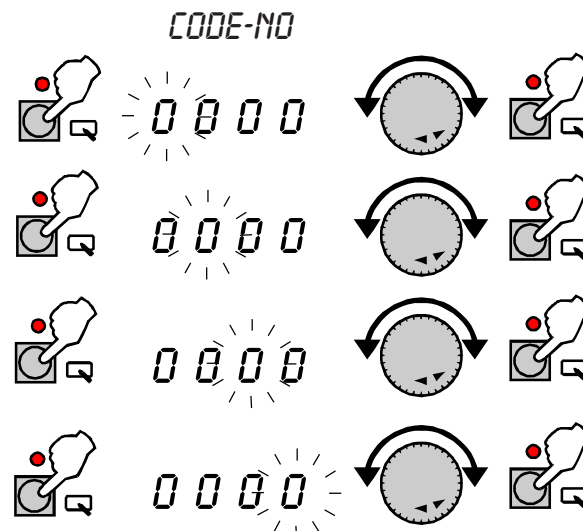

2.5 DISPLAY ERROR CODES ON THE TGC THERMOREGULATOR - CASCADE MANAGER

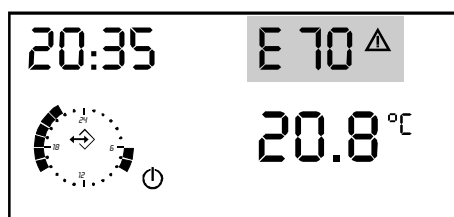

If faulty, a flashing triangle and relative fault code and faulty burner number will appear on the regulator screen.

Below are the boiler error codes, relative meanings and corrective actions.

For error codes relative to the heating system, consult the "Error Search" paragraph in the "Instructions for Use" manual provided with the TGC thermoregulator.

Code Meaning

- E1 Thermostat trigger limit
- E2 Gas supply pressure low
- E4 No flame during burner ignition cycle
- E5 No flame during burner operation
- E6 High element temperature (>95°C)
- E10 Internal fault in local control board (EB)
- E11 Flame presence detected before burner ignition cycle
- E12 Faulty local flow sensor
- E13 Faulty flow sensor (HP)
- E14 Faulty global return sensor
- E15 Difference between global return sensor and local flow sensor of > 30°C (rp +10)
- E16 Exchanger temperature very low: probable danger of ice
- E20 Flame presence detected after burner is switched off
- E22 The air pressure switch does not switch within 30" of the beginning of the burner ignition cycle
- E23 Air pressure switch contact always on
- E24 Fan out of control: it does not reach the correct speed within 30" of the beginning of the burner ignition cycle
- E26 Fan out of control: the fan does not stop within 30" of the end of operation
- E27 The air pressure switch detects a fault during the burner ignition cycle
- E28 Obstructed flue pipe
- E29 Water in the exhaust chamber, excessive condensate level, check whether the trap is obstructed
- E30 Change in parameter settings
- E32 Supply voltage below 190 Vac
- E40 Poor system water circulation
- E69 TGC: F5 – flow temperature probe Heating Circuit 2
- E70 TGC: F11 – flow temperature probe Heating Circuit 1
- E71 TGC: F1 – buffer below temperature probe (Buffer)
- E72 TGC: F3 – buffer above temperature probe (Buffer)
- E75 TGC: F9 – external temperature probe
- E76 TGC: F6 – DHW storage tank temperature probe
- E78 TGC: F8 – boiler temperature probe (kf)
- E80 TGC: F2 – room temperature sensor Heating Circuit 1

- E81 TGC: EEPROM error. The value is not valid, it has been replaced with the standard value
- E83 TGC: F15 – room temperature sensor Heating Circuit 2
- E90 TGC: Address 0 and 1 in the BUS. The bus 0 and 1 codes cannot be used simultaneously
- E91 TGC: BUS code occupied. The set BUS code is already being used by another appliance
- E99 TGC: Internal fault
- E135 TGC: F12 – DHW storage tank below temperature probe MF2
- E136 TGC: F13 – Heat Generator 2, manifold 2 MF3
- E137 TGC: F14 – manifold 1, MULTIFUNCTION 4
- E138 TGC: F15 – Room temperature sensor Heating Circuit 2
- E200 TGC: Safety device intervention (fans at max rpm) / Communication error module 1
- E201 TGC: Communication error module 2
- E203 TGC: Communication error module 3
- E204 TGC: Communication error module 4
- E205 TGC: Communication error module 5
- E206 TGC: Communication error module 6
- E207 TGC: Communication error module 7

- E17 GCI: Frozen exchanger (<2°C)
- E18 GCI: Flow T Delta - Return 10° greater than Max dt parameter
- E19 GCI: Flow probe over temperature (>95° C)
- E37 GCI: Internal fault
- E38 GCI: settings corrupted by electromagnetic interference
- E56 GCI: No remote control detected
- E57 GCI: No EB detected
- E58 GCI: Global flow probe faulty.

3 QUICK GUIDE

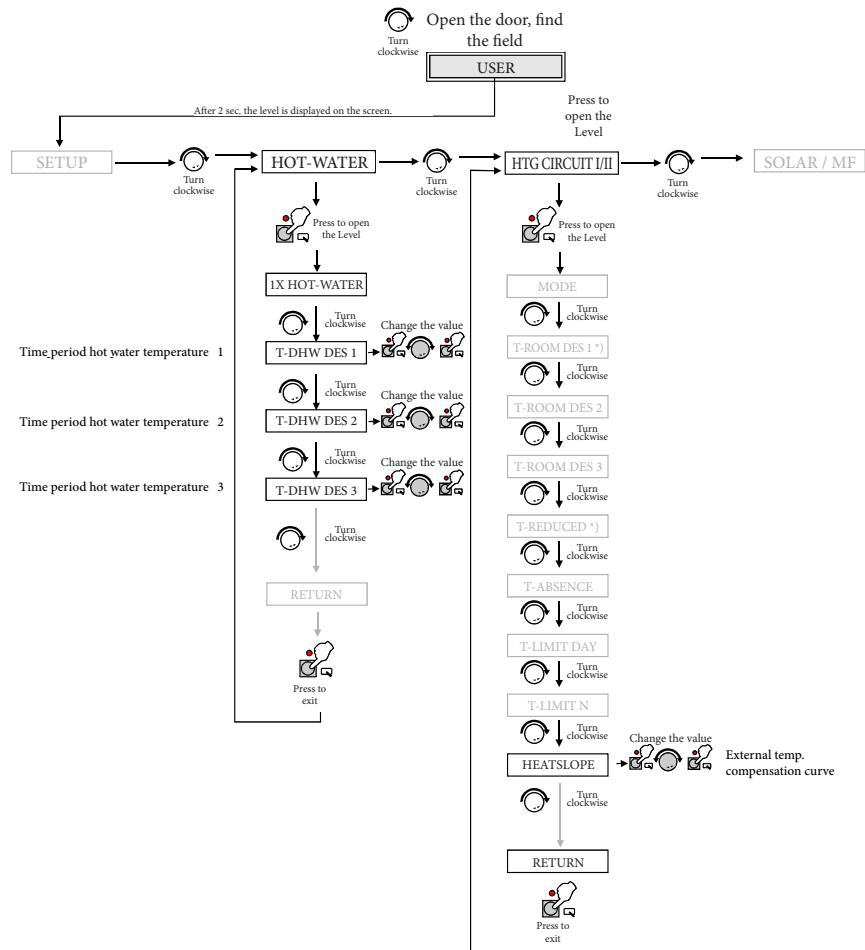
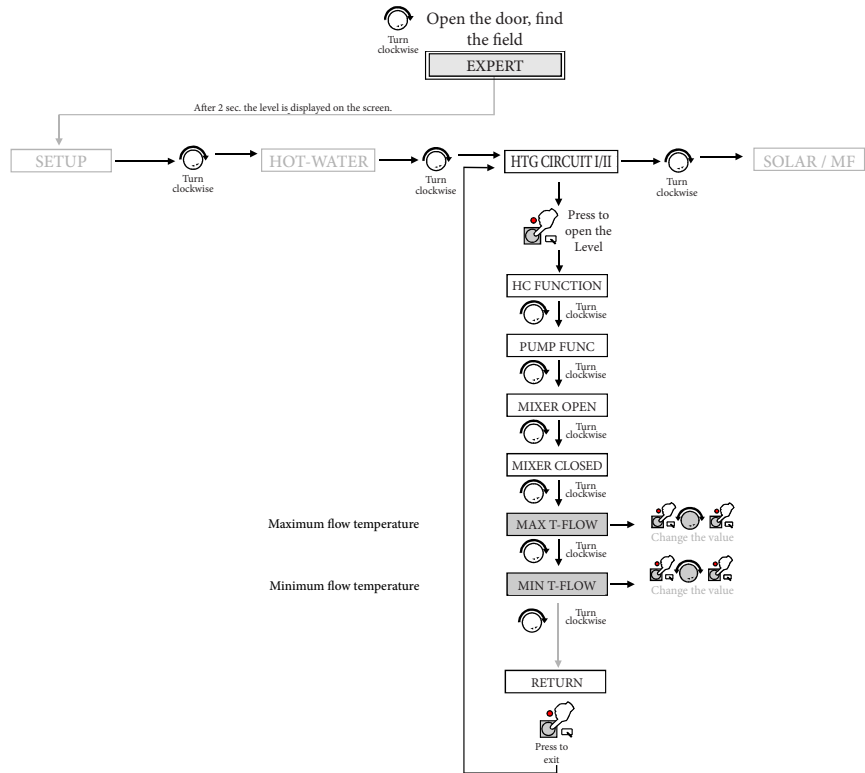

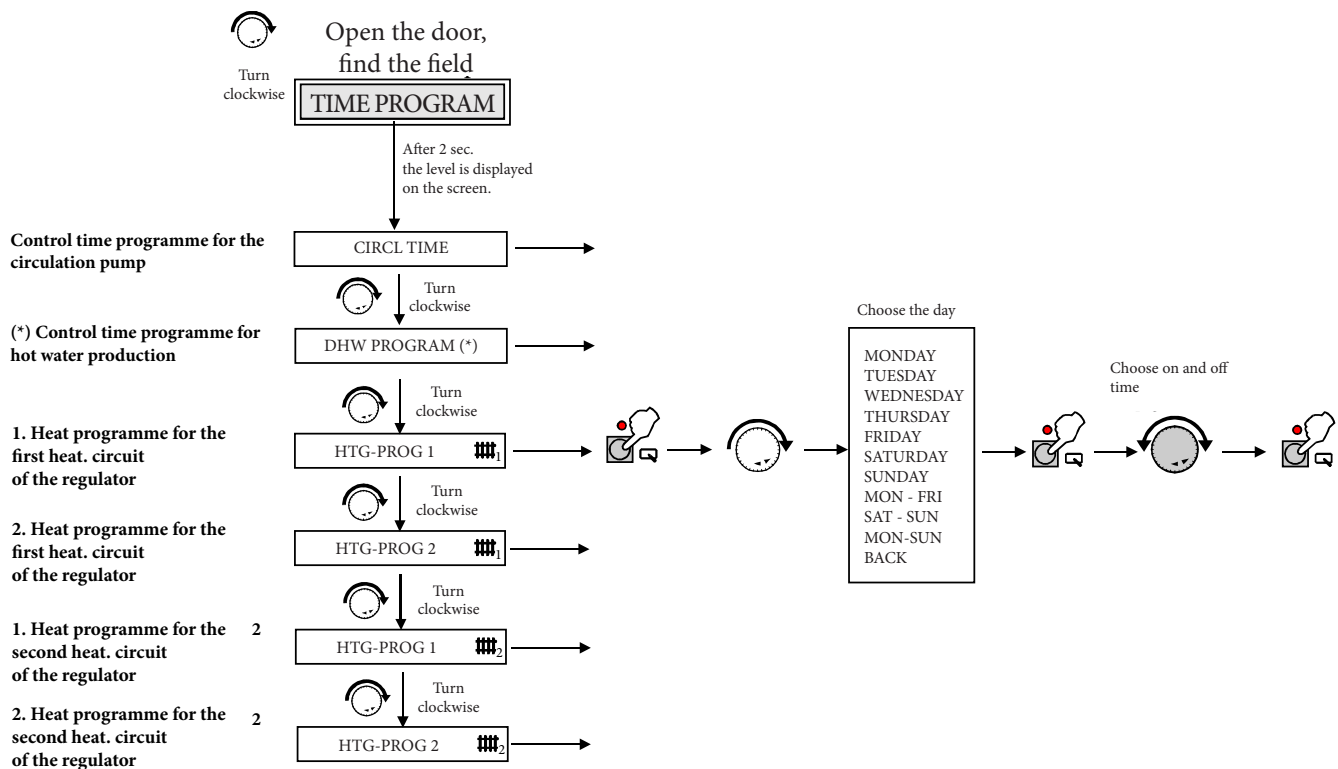
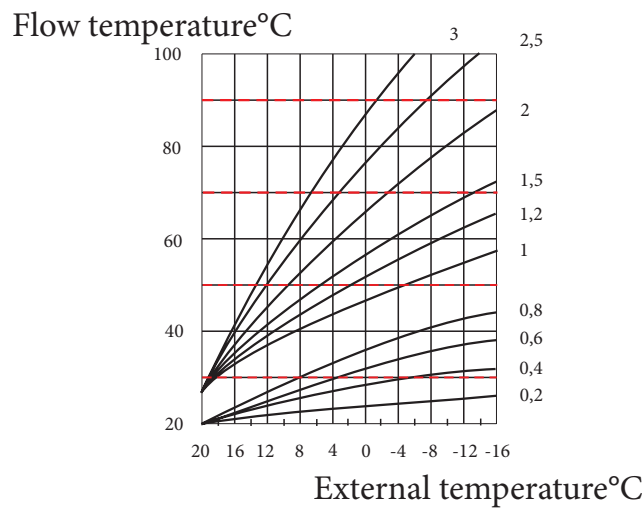

Note:

- 1 This manual does not replace the one for the TGC thermoregulator, but it is simply an integration designed to simplify operations and understanding.
- 2 For electrical connections, always consult the boiler installation manual.

Follow us

Immergas Italia



immergas.com

Immergas S.p.A.
42041 Brescello (RE) - Italy
Tel. 0522.689011
Fax 0522.689617

ISO 9001 certified company

Certified company ISO 9001

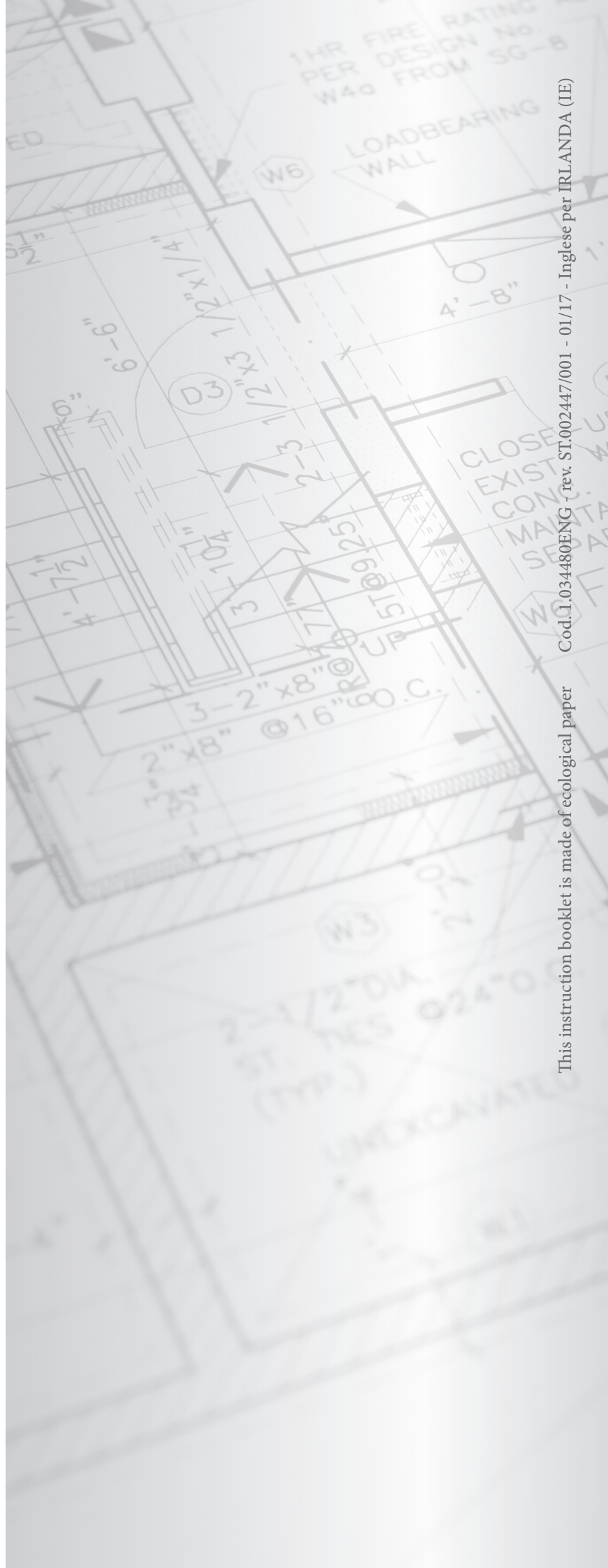

This instruction booklet is made of ecological paper

Cod. I.034480ENG - rev. ST.002447/001 - 01/17 - Inglese per IRLANDA (IE)