

MANUAL  
OWNER'S

Instructions and warnings **IE**  
Installer  
User  
Maintenance technician

\*1.042035ENG\*



## CAESAR ECO 11-14

Wall-hung instantaneous water heaters with sealed chamber (type C) and fan assisted or open chamber (type B) and fan assisted





## **Dear Customer,**

*Congratulations for having chosen a top-quality Immergas product, able to assure well-being and safety for a long period of time. As an Immergas Customer, you can also count on a qualified after-sales service, prepared and updated to guarantee constant efficiency of your water heater. Read the following pages carefully: you will be able to draw useful tips on the proper use of the device, compliance with which will confirm your satisfaction with the Immergas product. For assistance and scheduled maintenance contact Authorised After-Sales centres: they have original spare parts and are specifically trained directly by the manufacturer.*

## **General warnings**

*All Immergas products are protected with suitable transport packaging.*

*The material must be stored in a dry place protected from the weather.*

*The instruction booklet is an integral and essential part of the product and must be given to the new user in the case of transfer or succession of ownership.*

*It must be stored with care and consulted carefully, as all of the warnings provide important safety indications for installation, use and maintenance stages.*

*This instructions manual provides technical information for installing Immergas water heaters. As for the other issues related to water heater installation (e.g. safety in the work site, environment protection, injury prevention), it is necessary to comply with the provisions of the regulations in force and the principles of good practice.*

*Installation and maintenance must be performed in compliance with the regulations in force, according to the manufacturer's instructions and by professionally qualified staff, intended as staff with specific technical skills in the system sector, as envisioned by the Law.*

*Improper installation or assembly of the Immergas appliance and/or components, accessories, kits and devices can cause unexpected problems for people, animals and objects. Read the instructions provided with the product carefully to ensure proper installation.*

*Maintenance must be carried out by skilled technical staff. The Authorised After-Sales Service represents a guarantee in terms of qualifications and professionalism.*

*The appliance must only be destined for the use for which it has been expressly declared. Any other use will be considered improper and therefore potentially dangerous.*

*If errors occur during installation, operation and maintenance, due to non-compliance with technical laws in force, standards or instructions contained in this book (or however supplied by the manufacturer), the manufacturer is excluded from any contractual and extra-contractual liability for any damage and the appliance warranty is invalidated.*

The company **IMMERGAS S.p.A.**, with registered office in via Cisa Ligure 95 42041 Brescello (RE), declares that the design, manufacturing and after-sales assistance processes comply with the requirements of standard **UNI EN ISO 9001:2015**.

For further details on the product CE marking, request a copy of the Declaration of Conformity from the manufacturer, specifying the appliance model and the language of the country.

The manufacturer declines all liability due to printing or transcription errors, reserving the right to make any modifications to its technical and commercial documents without forewarning.

# INDEX

## INSTALLER page

1	Installation water heater.....	5
1.1	Installation recommendations.....	5
1.2	Main dimensions.....	6
1.3	Antifreeze protection.....	7
1.4	Gas connection.....	7
1.5	Hydraulic connection.....	7
1.6	Electrical connection.....	7
1.7	Immergas flue systems.....	8
1.8	Tables of Resistance Factors and Equivalent Lengths.....	9
1.9	Concentric horizontal kit installation....	10
1.10	Concentric vertical kit installation.....	10
1.11	Separator kit installation.....	11
1.12	Ducting of flues or technical slots.....	12
1.13	Installation of boiler type B with open chamber and fan assisted (optional).....	12
1.14	Flue exhaust to flue/chimney.....	12
1.15	Flues, chimneys and chimney pots.....	12
1.16	Gas system start-up.....	12
1.17	Water heater start up (ignition).....	12
1.18	Procedure for first ignition, preparation to use the appliance.....	13
1.19	Kits available on request.....	13
1.20	Water heater components.....	14

## USER page

2	Instructions for use and maintenance....	15
2.1	Cleaning and maintenance.....	15
2.2	General warnings.....	15
2.3	Quick appliance operation guide.....	15
2.4	Control panel.....	16
2.5	Faults and screen displays.....	16
2.6	Emptying the water heater.....	17
2.7	Anti-freeze protection (optional).....	17
2.8	Cleaning the case.....	17
2.9	Decommissioning.....	17
2.10	Gas system not used for periods over 12 months.....	17

## MAINTENANCE TECHNICIAN page

3	Check and maintenance.....	18
3.1	Hydraulic diagram.....	18
3.2	Wiring diagram.....	19
3.3	Service Menu.....	20
3.4	Possible problems and their causes.....	21
3.5	Converting the water heater to other types of gas.....	22
3.6	Solar panels coupling function.....	23
3.7	Check the network pressure (minimum power supply pressure - only with appliances operating with methane).....	23
3.8	Yearly appliance check and maintenance.....	23
3.9	Casing removal.....	24
3.10	Combustion parameters.....	25
3.11	Technical data.....	25
3.12	Product fiche (in compliance with Regulation 812/2013).....	26
3.13	Parameters for filling in the package fiche.....	27



# 1 INSTALLATION WATER HEATER.

## 1.1 INSTALLATION RECOMMENDATIONS.

The water heaters have been designed for wall installation only, for the production of domestic hot water in domestic and similar uses.

The place of installation of the appliance and relative Immergas accessories must have suitable features (technical and structural), such as to allow for (always in safe, efficient and comfortable conditions):

- installation (according to the provisions of technical legislation and technical regulations);
- maintenance operations (including scheduled, periodic, routine and special maintenance);
- removal (outdoors in the place for loading and transporting the appliances and components) as well as their eventual replacement with appliances and/or equivalent components.

In the case of wall installation the wall surface must be smooth, without any protrusions or recesses enabling access to the rear part. They are not designed to be installed on plinths or floors (Fig. 1).

By varying the type of installation the classification of the water heater also varies, precisely:

- **Type B<sub>22</sub> water heater** if installed using the relevant terminal for air intake directly from the room in which the water heater has been installed.
- **Type C water heater** if installed using concentric pipes or other types of pipes envisioned for the sealed chamber water heaters for intake of air and expulsion of fumes.

Only professionally qualified companies are authorised to install Immergas gas appliances. Installation must be carried out according to regulation standards, current legislation and in compliance with local technical regulations and the required technical procedures.

**Attention:** it is forbidden to install water heaters removed from other systems. The manufacturer declines all liability in the event of damage caused by water heaters removed from other systems or for any non-conformities with such equipment.

**Attention: before commissioning the water heater, if it is operated with LPG, make sure parameters 2 and 13 on page 20 have been set correctly.**

Installation of the water heater when powered by LPG must comply with the rules regarding gases with a greater density than air (remember, as an example, that it is prohibited to install systems powered with the above-mentioned gas in rooms where the floor is at a lower quota than the average external country one). Before installing the appliance, ensure it has been delivered in perfect condition; if in doubt, contact the supplier immediately.

Packing materials (staples, nails, plastic bags, polystyrene foam, etc.) constitute a hazard and must be kept out of the reach of children. If the appliance is installed inside or between cabinets, ensure sufficient space for normal servicing; therefore, leave clearance of at least 5 cm between the water heater casing and the vertical sides of the cabinet. Leave adequate space above and below the water heater for possible water and flue removal connections (Ref. Fig. 2).

Keep all flammable objects away from the appliance (paper, rags, plastic, polystyrene, etc.). It is recommended not to position household appliances under the water heater because they could undergo damage in the case of leaks from the hydraulic fittings. If this is not the case, the manufacturer cannot be considered liable for any damage caused to the household appliances. For the aforementioned reasons, we recommend not placing furnishings, furniture, etc. under the water heater.

In the event of malfunctions, faults or incorrect operation, turn the appliance off and contact an authorised company (e.g. the Authorised Technical Assistance centre, which has specifically trained staff and original spare parts). Do not attempt to modify or repair the appliance alone. Failure to comply with the above implies personal responsibility and invalidates the warranty.

### • Installation Standards:

- this water heater was designed and built for installation inside buildings.
- Installation of gas appliances, flue exhaust pipes and combustion air intake pipes is forbidden in places with a fire risk (for example: garages, closed parking stalls), and in potentially dangerous places.
- Installation on the vertical projection of cooking hobs is forbidden.
- Installation is forbidden in places/rooms that constitute public areas of apartment buildings, internal stairways or other escape routes (e.g. floor landings, entrance halls, etc.).
- Installation is also forbidden in places/rooms that constitute public areas of apartment buildings such as cellars, entrance halls, attics, lofts, etc., unless otherwise provided for by local regulations in force.
- It is forbidden to install the water heater inside a closed recessed frame (e.g. Omni Container).
- The appliance was designed to be installed in indoor and protected places.
- It must also be installed in an environment in which the temperature cannot fall below 0°C. It must not be exposed to atmospheric agents.

*If the water heater is installed in a place whose temperature drops below 0°C, it is compulsory to use the antifreeze accessory that provides for adequate protection down to -15°C.*

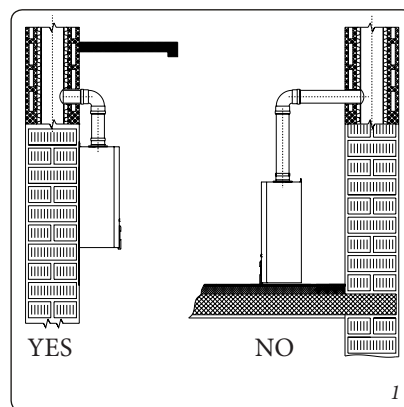

- It is prohibited to obstruct the air intake and aeration grids where the appliance is installed.

**Attention:** wall mounting of the water heater must guarantee stable and efficient support for the generator.

*The fastening plugs (standard supply) are only to be used to fix the water heater to the wall; they only ensure adequate support if inserted correctly (according to technical standards) in walls made of solid or semi-hollow brick or block. In the case of walls made from hollow brick or block, partitions with limited static properties, or in any case walls other than those indicated, a static test must be carried out to ensure adequate mount.*

These appliances are used to heat water to below boiling temperature in atmospheric pressure.

They must be connected to a DHW distribution network suited to their performance and power.

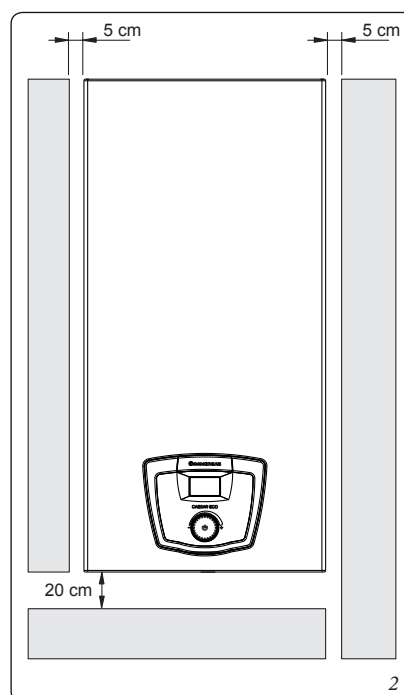

INSTALLER

USER

MAINTENANCE TECHNICIAN

1.2 MAIN DIMENSIONS.

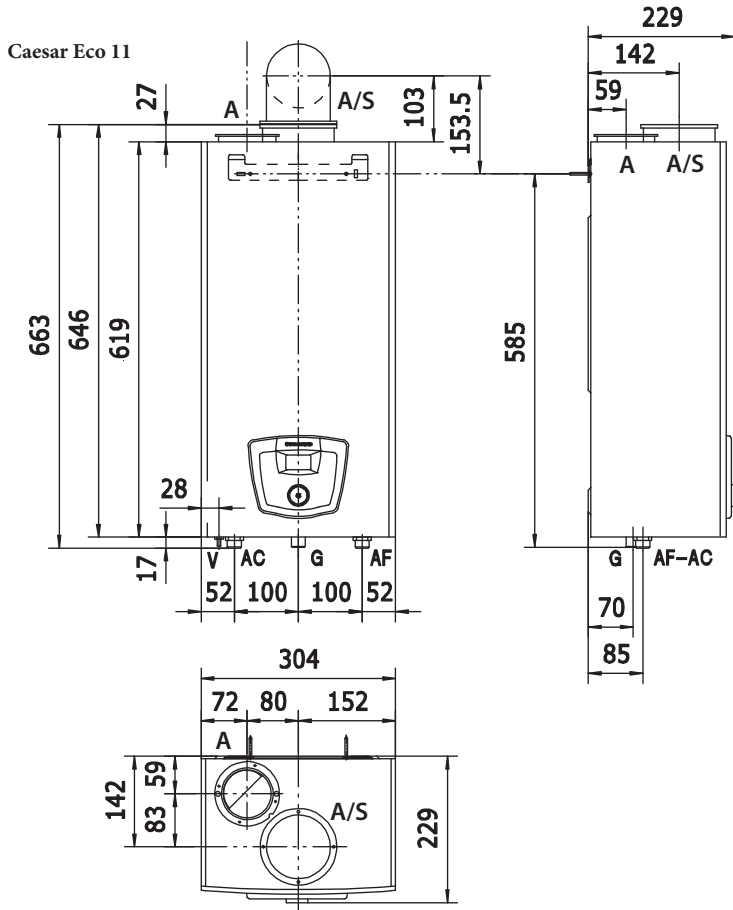

CONNECTIONS		
GAS	DOMESTIC HOT WATER	
G	AC	AF
3/4"	1/2"	1/2"

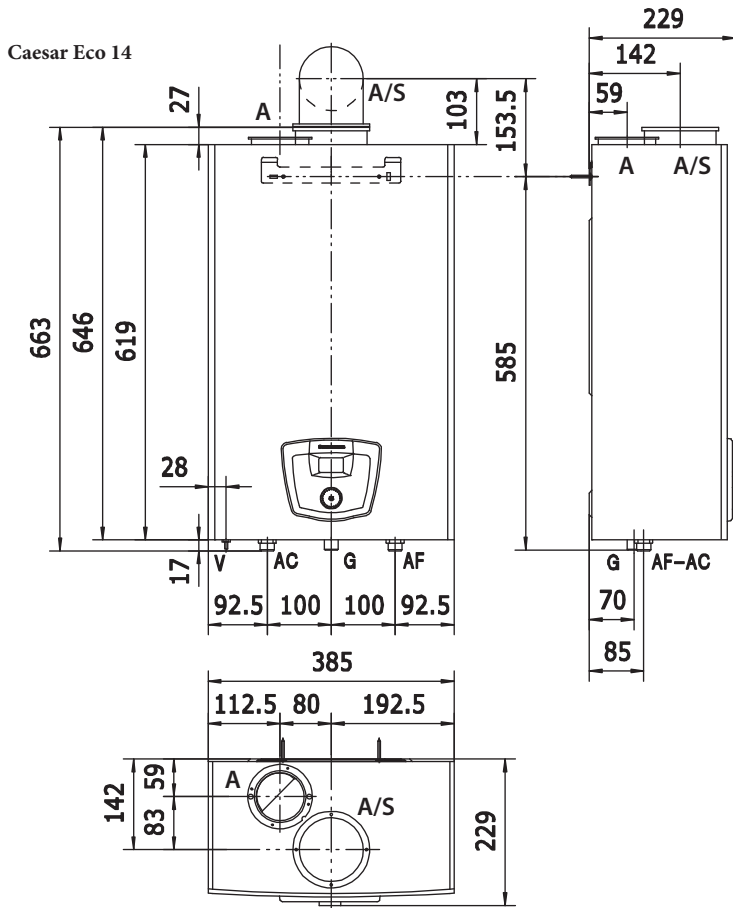

- Key:
- AC - Domestic hot water outlet
  - AF - Domestic hot water inlet
  - G - Gas supply
  - V - Electrical connection
  - A - Intake
  - S - Exhaust
  - A/S - Intake/Exhaust

### 1.3 ANTIFREEZE PROTECTION.

**Minimum temperature.** If the water heater is installed in a place where the temperature falls below 0°C, the connection pipes must be insulated and, in the event there is no gas (or the water heater goes into no ignition block), the appliance can freeze.

To prevent the risk of freezing follow the instructions below:

- Protect the domestic hot water circuit against freezing by using an accessory that is supplied on request (anti-freeze kit) comprising two electric heating elements, the relevant cables and a control thermostat (carefully read and follow the installation instructions contained in the accessory kit pack).

Water heater anti-freeze protection is thus ensured only if:

- the water heater is correctly connected to electricity power supply circuits;
- the main switch is on;
- the antifreeze kit is installed correctly;
- the connection pipes are insulated.

In these conditions the water heater is protected against freezing to temperature of -15°C.

The warranty does not cover damage due to interruption of the electrical power supply and failure to comply with that stated on the previous page.

### 1.4 GAS CONNECTION.

Our water heaters are designed to operate with methane gas (G20) and LPG. Supply pipes must be the same as or larger than the 3/4" G water heater fitting. Before connecting the gas line, carefully clean inside all the fuel feed system pipes to remove any residue that could impair water heater efficiency. Also make sure the gas corresponds to that for which the water heater is prepared (see water heater data-plate). If different, the water heater must be converted for operation with the other type of gas (see converting appliance for other gas types). It is also important to check the dynamic pressure of the mains (methane or LPG) used to supply the water heater, which must comply with EN 437 and its attachment, as insufficient levels may reduce generator output and cause discomfort to the user.

Ensure correct gas cock connection. The gas supply pipe must be suitably dimensioned according to current regulations in order to guarantee correct gas flow rate to the burner even in conditions of maximum generator output and to guarantee appliance efficiency (technical specifications). The coupling system must conform to standards in force (EN 1775).

**Fuel gas quality.** The appliance was designed to operate with combustible gas free of impurities; otherwise it is advisable to fit special filters upstream of the appliance to restore the purity of the fuel.

**Storage tanks (in case of supply from LPG depot).**

- New LPG storage tanks may contain residual inert gases (nitrogen) that degrade the mixture delivered to the appliance causing functioning anomalies.
- Due to the composition of the LPG mixture, layering of the mixture components may occur during the period of storage in the tanks. This can cause a variation in the calorific value of the mixture delivered to the appliance, with subsequent change in its performance.

### 1.5 HYDRAULIC CONNECTION.

**Attention:** before connecting the water heater and so as not to make the warranty null and void on the DHW heat exchanger, wash the system thoroughly (piping, etc.) in a way to remove any residue that could compromise the good functioning of the water heater.

Water connections must be made in a rational way using the couplings on the water heater template.

**Attention:** to preserve the duration and features of appliance efficiency, in the presence of water whose features can lead to the deposit of lime scale, it is necessary to install the "polyphosphate dispenser" kit.

### 1.6 ELECTRICAL CONNECTION.

The "Caesar Eco" water heater has an IPX5D protection rating for the entire appliance. Electrical safety of the appliance is reached only when it is correctly connected to an efficient earthing system as specified by current safety standards.

**Attention:** the manufacturer declines any responsibility for damage or physical injury caused by failure to connect the water heater to an efficient earth system or failure to comply with the technical reference standards.

Also ensure that the electrical installation corresponds to maximum absorbed power specifications as shown on the water heater data-plate. Water heaters are supplied complete with an "X" type power cable without plug. The power cable must be connected to a 230V ±10% / 50Hz mains, respecting L-N polarity and the earthing connection ; this network must have a multi-pole circuit breaker with Class III overvoltage category. If the power supply cable is damaged, it must be replaced by a special cable or assembly, which are only available from the manufacturer or its After-sales Service. It is recommended to contact a qualified company (e.g. the Authorised After-Sales Technical Assistance Service) for replacement to avoid a hazard. The power cable must be laid as shown (Fig. 4). If the network fuse on the connection terminal block needs replacing, this must also be done by qualified personnel: use a 3.15 A fast fuse. For the main power supply to the appliance, never use adapters, multiple sockets or extension leads.

**N.B.:** all water heater pipes must never be used to earth the electric or telephone lines. Ensure elimination of this risk before making the water heater electrical connections.

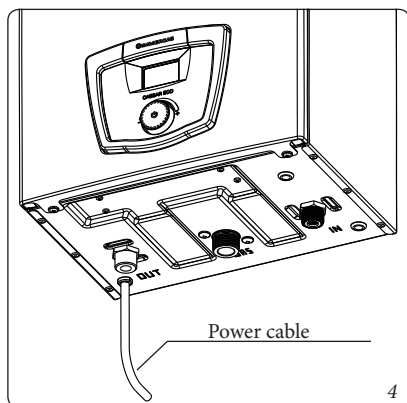

**1.7 IMMERGAS FLUE SYSTEMS.**

Immergas supplies various solutions separately from the water heaters regarding the installation of air intake terminals and flue extraction, which are fundamental for water heater operation.

**Attention: The water heater must only be installed together with an original Immergas air intake and flue gas exhaust system, in compliance with the standards in force. This system can be identified by an identification mark and special distinctive marking bearing the note "not for condensing boilers".**

The flue exhaust pipes must not be in contact with or be near to flammable materials. Moreover, they must not pass through buildings or walls made of flammable material.

- **Positioning of double lip seals.** For correct positioning of lip seals on elbows and extensions, follow the assembly direction (Fig. 5).
- **Coupling extension pipes and concentric elbows.** To install snap-fit extensions with other elements of the flue extraction elements assembly, follows:

Fit the concentric pipe or elbow with the male side (smooth) on the female section (with lip seal) to the end stop on the previously installed element. This will ensure sealing and joining of the elements correctly.

**Attention:** if the exhaust terminal and/or concentric extension pipe needs shortening, consider that the internal duct must always protrude by 5 mm with respect to the external duct.



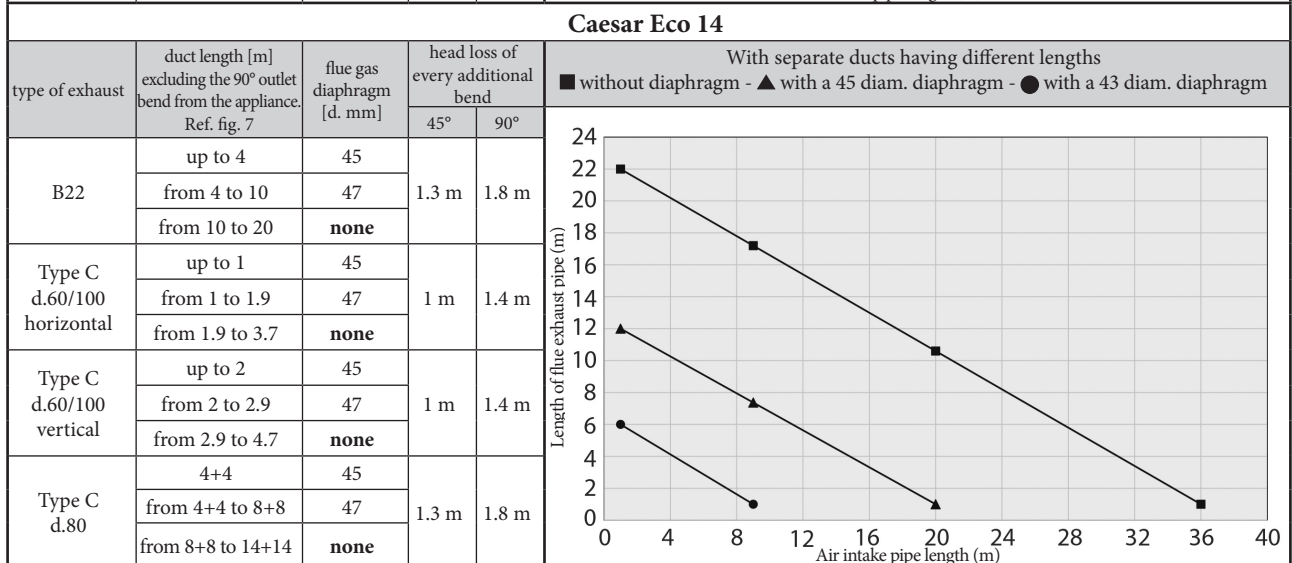
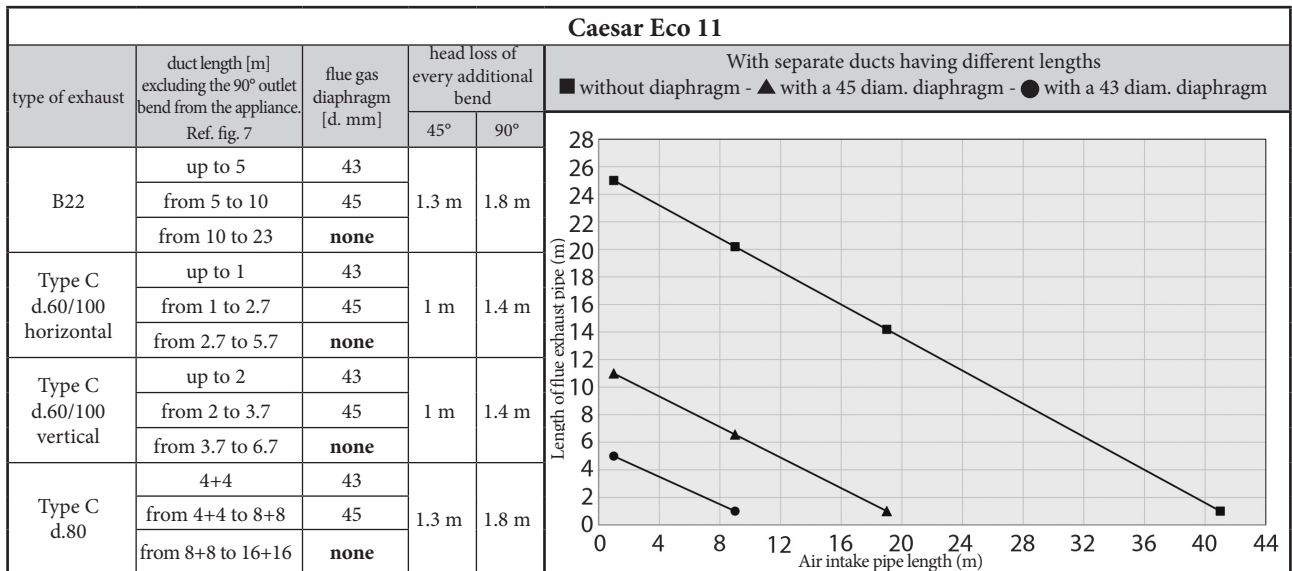
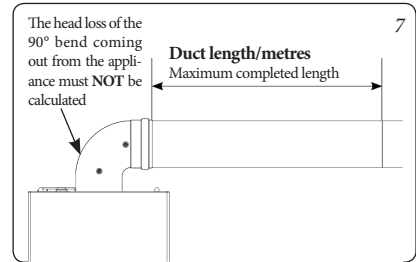
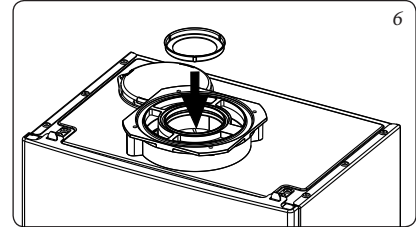
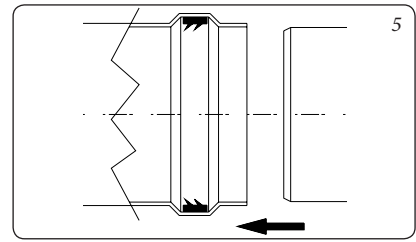

- **N.B.:** for safety purposes, do not obstruct the water heater intake-exhaust terminal, even temporarily.
- **N.B.:** when installing horizontal pipes, a minimum inclination towards the water either of 3% must be maintained and a section clamp with plug must be installed every 3 metres.
- **Diaphragm installation.** For proper water heater operation, a diaphragm must be installed on the outlet of the sealed chamber and before the exhaust pipe (Fig. 6).

**N.B.:** the diaphragm is supplied as per standard with the water heater.

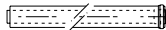
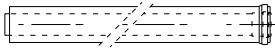
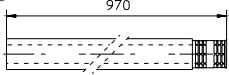

**Attention: if installation requires significant flue exhaust sections, it is necessary to consider the formation of condensate and thus use the "blue series" insulated type of flue.**

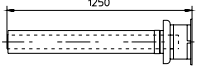
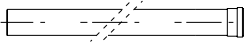
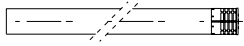
1.8 TABLES OF RESISTANCE FACTORS  
AND EQUIVALENT LENGTHS.

TYPE OF DUCT	Length in m of concentric pipe Ø 60/100	Length in metres of pipe Ø 80
Concentric pipe Ø 60/100 m 1 	m 1	Intake m 7.1
		Exhaust m 5.5
Terminal complete with intake-exhaust horizontal concentric Ø 60/100 	m 2.8	Intake m 20
		Exhaust m 15
Intake-exhaust terminal horizontal concentric Ø 60/100 	m 1.9	Intake m 14
		Exhaust m 10.6
Intake-exhaust terminal vertical concentric Ø 60/100 	m 2.5	Intake m 18
		Exhaust 14
Pipe Ø 80 m 1 (with and without insulation) 	m 0.1	<b>Intake m 1.0</b>
	m 0.2	<b>Exhaust m 1.0</b>
Complete intake terminal Ø 80 m 1 (with or without insulation) 	m 0.3	<b>Intake m 2.2</b>
Intake terminal Ø 80 Exhaust terminal Ø 80 	m 0.2	<b>Intake m 1.3</b>
	m 0.1	<b>Exhaust m 0.8</b>
Split parallel Ø 80 from Ø 60/100 to Ø 80/80 	m 0.5	<b>Intake m 3.8</b>
		<b>Exhaust m 2.9</b>

INSTALLER

USER

MAINTENANCE TECHNICIAN

### 1.9 CONCENTRIC HORIZONTAL KIT INSTALLATION.

#### Type C configuration, sealed chamber and fan assisted.

Installation of this terminal is governed by current technical regulations.

This terminal is connected directly to the outside of the building for air intake and flue exhaust. The horizontal kit can be installed with the rear, right side, left side or front outlet.

- External grid. The Ø 60/100 intake/exhaust terminal, if properly installed, is pleasant to look at on the outside of the building. Make sure that the external silicone wall sealing plate is properly inserted in the wall.

**Horizontal intake-exhaust kit Ø 60/100.** Kit assembly (Fig. 8): install the bend with flange (2) onto the central hole of the water heater inserting the gasket (1) and tighten using the screws included in the kit. Couple the concentric terminal pipe Ø 60/100 (3) with the male end (smooth) into the female end (with lip seals) of the bend (2) up to the stop, making sure that the internal and external wall sealing plate have been fitted, this will ensure sealing and joining of the kit elements.

- Extensions for Ø 60/100 horizontal kit (Fig. 9). The kit with this configuration can be extended up to a *max. horizontal length of 5.7 m* (for Caesar Eco 11) and horizontal length of *3.7 m* (for Caesar Eco 14), including the terminal with grid and excluding the concentric bend leaving the water heater. In this case the special extensions must be requested.

### 1.10 CONCENTRIC VERTICAL KIT INSTALLATION.

#### Type C configuration, sealed chamber and fan assisted.

Concentric vertical intake and exhaust kit. This vertical terminal is connected directly to the outside of the building for air intake and flue exhaust.

**N.B.:** the vertical kit with aluminium tile enables installation on terraces and roofs with a maximum slope of 45% (approx 25°) and the height between the terminal cap and half-shell (374 mm) must always be respected.

#### Vertical kit with aluminium tile Ø 60/100.

To use this kit one must use the fixing plate kit 60/100 (sold separately).

Kit assembly (Fig. 10): install the concentric flange (2) on the central hole of the water heater inserting the gasket (1) and tighten using the screws in the kit. Fit the male end (smooth) of the adapter (3) into the female end of the concentric flange (2). Imitation aluminium tile installation. Replace the tile with the aluminium sheet (5), shaping it to ensure that rainwater runs off. Position the fixed half-shell (7) and insert the intake-exhaust pipe (6). Fit the Ø 80/125 concentric terminal pipe with the male end (6) (smooth) to the female end of the adapter (3) (with lip gasket) up to the stop; making sure that the wall sealing plate (4) has been fitted, this will ensure sealing and joining of the elements making up the kit.

- Extensions for vertical kit Ø 60/100 (Fig. 11). The kit with this configuration can be extended up to *maximum 6.7 vertical rectilinear metres* (for Caesar Eco 11) and *4.7 vertical rectilinear metres* (for Caesar Eco 14), including the terminal. This configuration corresponds to a resistance factor of 100. In this case specific extensions must be requested.

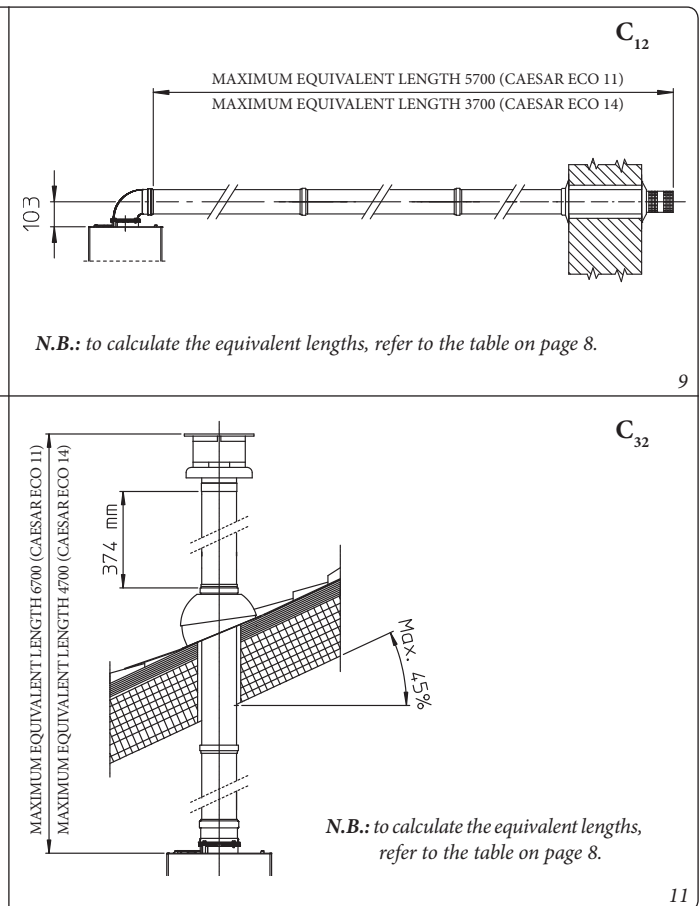
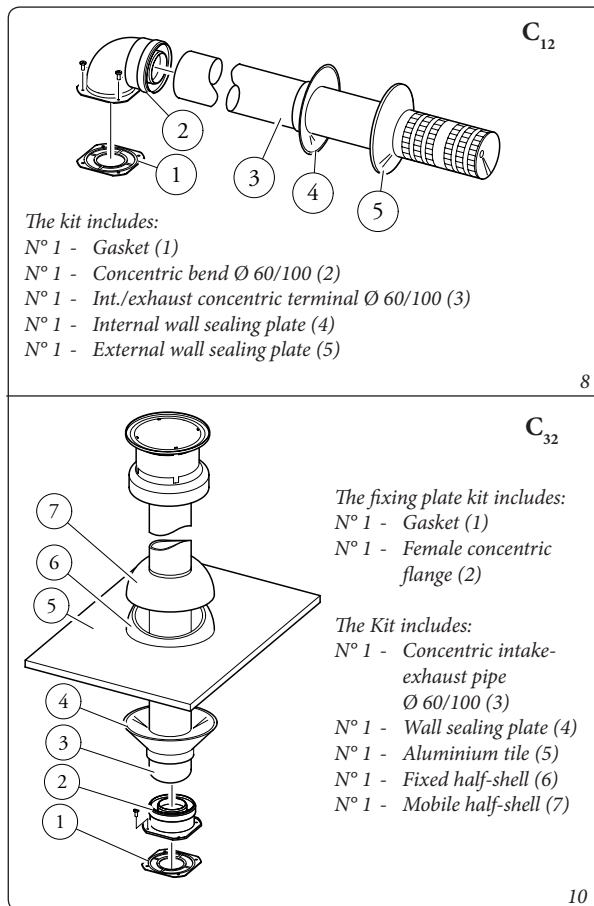



**1.11 SEPARATOR KIT INSTALLATION.**  
**Type C configuration, sealed chamber and fan assisted.**

This kit allows air to come in from outside the building and the fumes to exit from the chimney or flue through divided flue exhaust and air intake pipes. Combustion products are expelled from pipe (S). The required amount of air is taken in through pipe (A) for combustion. Both ducts can be routed in any direction.

**Separator kit Ø 80/80.** Kit assembly (Fig. 12): install the flange (4) on the central hole of the water heater, interposing the gasket (1) and tighten with the flat-tipped hex screws included in the kit. Remove the flat flange present in the lateral hole with respect to the central one (according to needs) and replace it with the flange (3), positioning the gasket (2) already present on the water heater and tighten using the supplied self-threading screws.

Fit the male side (smooth) to the bends (5) in the female side of the flanges (3 and 4). Fit the intake terminal (6) with the male side (smooth) in the female side of the bend (5) up to the end stop, ensuring that the internal and external wall sealing plates are fitted. Fit the exhaust pipe (9) with the male end (smooth) in the female end of the bend (5) up to the stop, making sure that the internal wall sealing plate has been fitted, this will ensure sealing and joining of the kit elements.

- Installation clearances (Fig. 13). The minimum installation clearance measurements of the Ø 80/80 separator terminal kit have been stated in one limit condition.
- The figure (Fig. 14) shows the configuration with vertical exhaust and horizontal intake.
- Extensions for separator kit Ø 80/80. The maximum vertical rectilinear length (without bends) used for Ø80 intake and exhaust pipes can be calculated by using the graphs for ducts with different lengths on page 8.

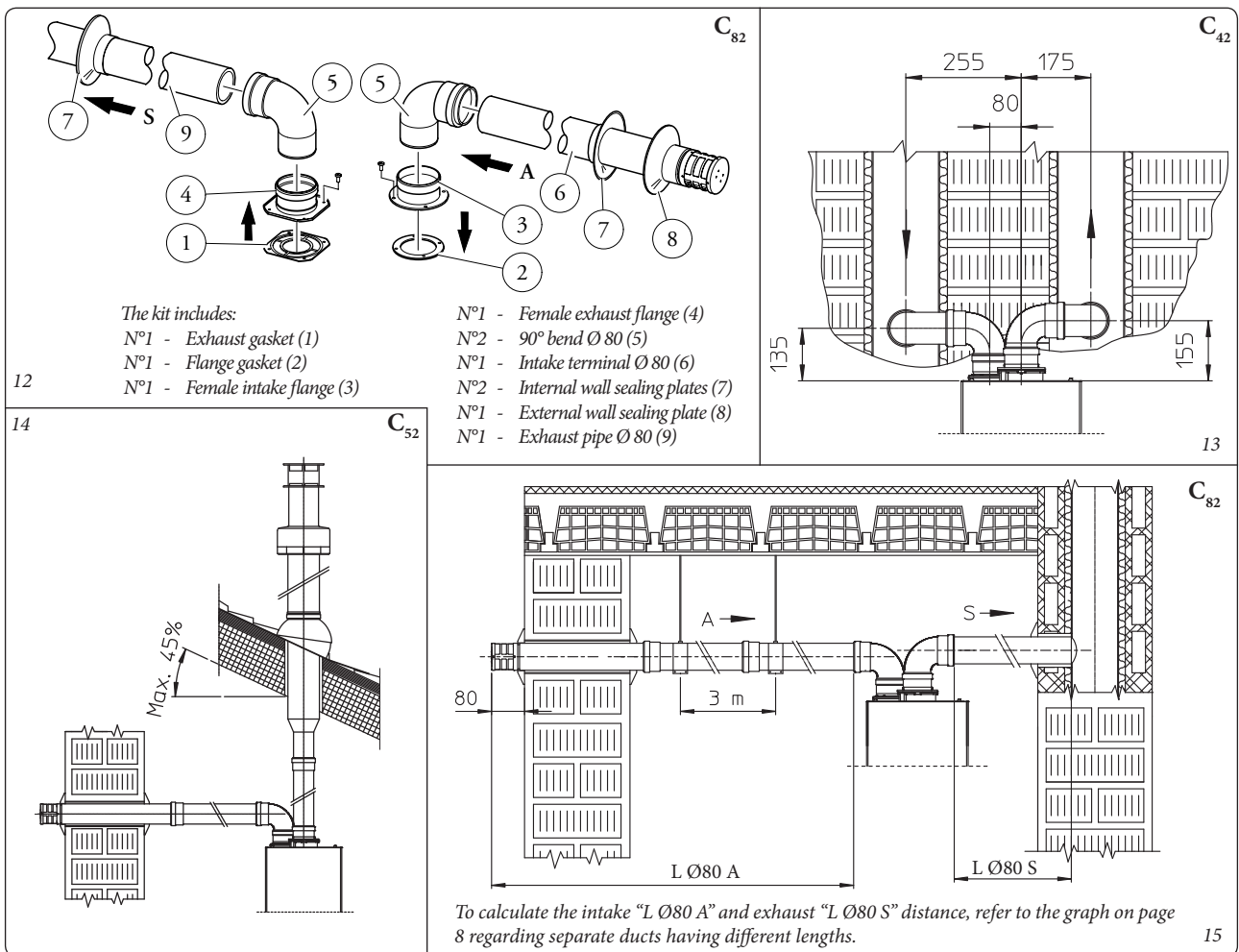

**Attention:** if the installation requires a significant development of the flue to the discharge, due consideration must be given to the formation of

condensate that could take place inside the pipe and Immergas insulated "Blue Series" flue kits must be used.

### 1.12 DUCTING OF FLUES OR TECHNICAL SLOTS.

With a specific "ducting system" it is possible to reuse existing flues, chimneys and existing or new technical slots to discharge the water heater fumes. Ducting requires ducts declared to be suitable for the purpose by the manufacturer, following the installation and user instructions, provided by the manufacturer and the requirements of the regulations in force.

### 1.13 INSTALLATION OF BOILER TYPE B WITH OPEN CHAMBER AND FAN ASSISTED (OPTIONAL).

This configuration requires use of a special terminal (Ref. 1 Fig. 16) (present in the intake kit for the installation in question) to be placed on the intake hole above the sealed chamber (Fig. 16). Air intake takes place directly from the environment and flue exhaust in individual chimney or to the outside.

With this configuration:

- air intake takes place directly from the environment in which the appliance is installed and only functions in permanently ventilated rooms, according to the regulations in force;
- the flue exhaust must be connected to its own individual flue or ducted directly into the external atmosphere;
- type B open chamber boilers must not be installed in places where commercial, artisan or industrial activities take place, which use products that may develop volatile vapours or substances (e.g. acid vapours, glues, paints, solvents, combustibles, etc.), as well as dusts (e.g. dust deriving from the working of wood, coal fines, cement, etc.), which may be harmful for the components of the appliance and jeopardise operation.
- in configuration type B, the boilers must not be installed in bedrooms, bathrooms or in bedsits. The technical regulations in force must be respected.

#### Max. length of exhaust pipe.

*The exhaust pipe (both vertical or horizontal) can be extended to the maximum length indicated in the table on page 8.*

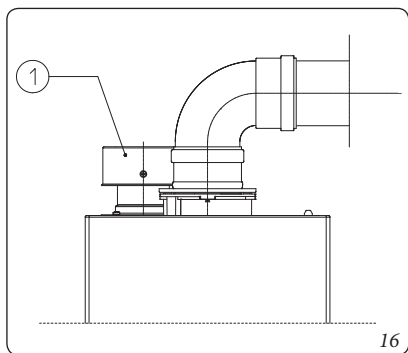

### 1.14 FLUE EXHAUST TO FLUE/CHIMNEY.

The flue exhaust does not necessarily have to be connected to a branched type traditional flue. The discharge of flue gases, just for the water heaters installed in configuration C, can be connected to a particular LAS type collective flue. For B<sub>22</sub> configurations, discharge is only allowed into individual flue or directly into the outside atmosphere by the relevant terminal. Multiple and combined flues must be specially designed according to the calculation method and requirements of the standards (such as EN 13384), by professionally qualified technical staff. Chimney or flue sections for connection of the flue exhaust pipe must comply with requisites of technical standards in force.

### 1.15 FLUES, CHIMNEYS AND CHIMNEY POTS.

The flues, chimneys and chimney caps for the evacuation of combustion products must be in compliance with the applicable standards in force.

**Positioning the exhaust terminals.** The exhaust terminals must:

- be installed on external perimeter walls of the building;
- be positioned according to the minimum distances specified in current technical standards.

**Combustion products exhaust of natural draught or fan assisted appliances in open-top closed environments.** In spaces closed on all sides with open tops (ventilation pits, courtyards etc.), direct combustion product exhaust is allowed for natural draught or fan assisted gas appliances with a heat input range from 4 to 35 kW, provided the conditions as per the current technical standards are respected.

### 1.16 GAS SYSTEM START-UP.

To start up the system, refer to the technical standards in force. In particular, for new gas systems:

- open windows and doors;
- avoid presence of sparks or naked flames;
- bleed all air from the pipelines;
- check that the internal system is properly sealed according to the specifications set forth by technical regulations in force.

### 1.17 WATER HEATER START UP (IGNITION).

**Attention: before commissioning the water heater, if it is operated with LPG, make sure parameters 2 and 13 on page 20 have been set correctly.**

To commission the water heater (the operations listed below must only be performed by qualified personnel and in the presence of staff only):

- check that the internal system is properly sealed according to the specifications set forth by regulations in force;
- ensure that the type of gas used corresponds to water heater settings;
- check connection to a 230V-50Hz power mains, correct L-N polarity and the earthing connection;
- check that there are no external factors that may cause the formation of fuel pockets;
- switch the water heater on and ensure correct ignition;
- ensure that the safety device intervenes in the event of gas supply failure and check the relative intervention time;
- check activation of the main switch located upstream of the water heater;
- check that the concentric intake-exhaust terminal (if fitted) is not blocked.

The water heater must not be started up even if only one of the checks should be negative.



**1.18 PROCEDURE FOR FIRST IGNITION, PREPARATION TO USE THE APPLIANCE.**

**Starting the appliance**

After checking everything, proceed as follows:

- power the water heater;
- open the gas cock installed upstream from the water heater;
- open the water tap in the lower part of the water heater;

Press the ignition button (⏻). The screen displays:

- The software revision.
- The type of gas set up on the water heater (nG: G20 - Bu: G30 - Pr: G31).
- LE indicating that it is a Low Emission product.
- Model of the water heater:
  - 1E (Caesar Eco 11)
  - 4E (Caesar Eco 14).

After the procedure, **before ignition**, the screen displays the symbols (- -) (Fig. 17).

Press the button (⏻) to start the water heater. The screen displays the value of the set temperature, the symbol (🚿) (in the event of hot water flow rate in progress) and the symbol (🔥) (in the event of burner operation) (Fig. 18).

**Regulation of the water temperature**

The water temperature can be set within a range of 37 and 60°C.

- Turn the ignition button clockwise to increase the temperature and anticlockwise to decrease it. The symbol (🚿) flashes for 5 seconds and the screen displays the new temperature set.

**Appliance switch-off**

- Press and hold the water heater switch-off button (⏻) for approximately 5 seconds;
- as soon as the symbols (- -) start flashing, release the button;
- the appliance will go OFF and the screen will display the fixed symbols (- -) (Fig. 17).

From this point on, the appliance is inactive (stand-by).

To restart the water heater again, press the ignition button (⏻).

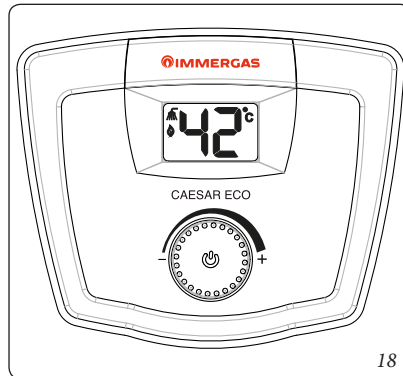
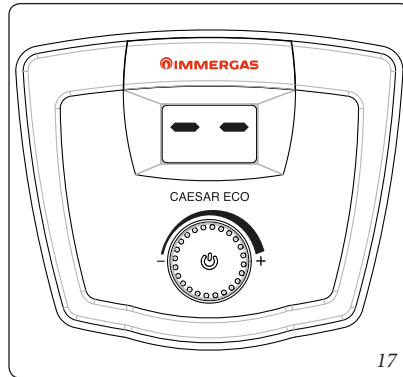

**1.19 KITS AVAILABLE ON REQUEST.**

- Polyphosphate dispenser kit. The polyphosphate dispenser reduces the formation of lime-scale and preserves the original heat exchange and domestic hot water production conditions. The water heater is prepared for application of the polyphosphate dispenser kit.
- Anti freeze kit with resistance (on request). If the water heater is installed in a place where the temperature falls below 0°C and the appliance can freeze. To prevent freezing of the domestic hot water system, an anti freeze kit with an electrical resistance can be fitted from the relative cable and from a control thermostat.

The above-mentioned kits are supplied complete with instructions for assembly and use.

1.20 WATER HEATER COMPONENTS.

INSTALLER

USER

MAINTENANCE TECHNICIAN

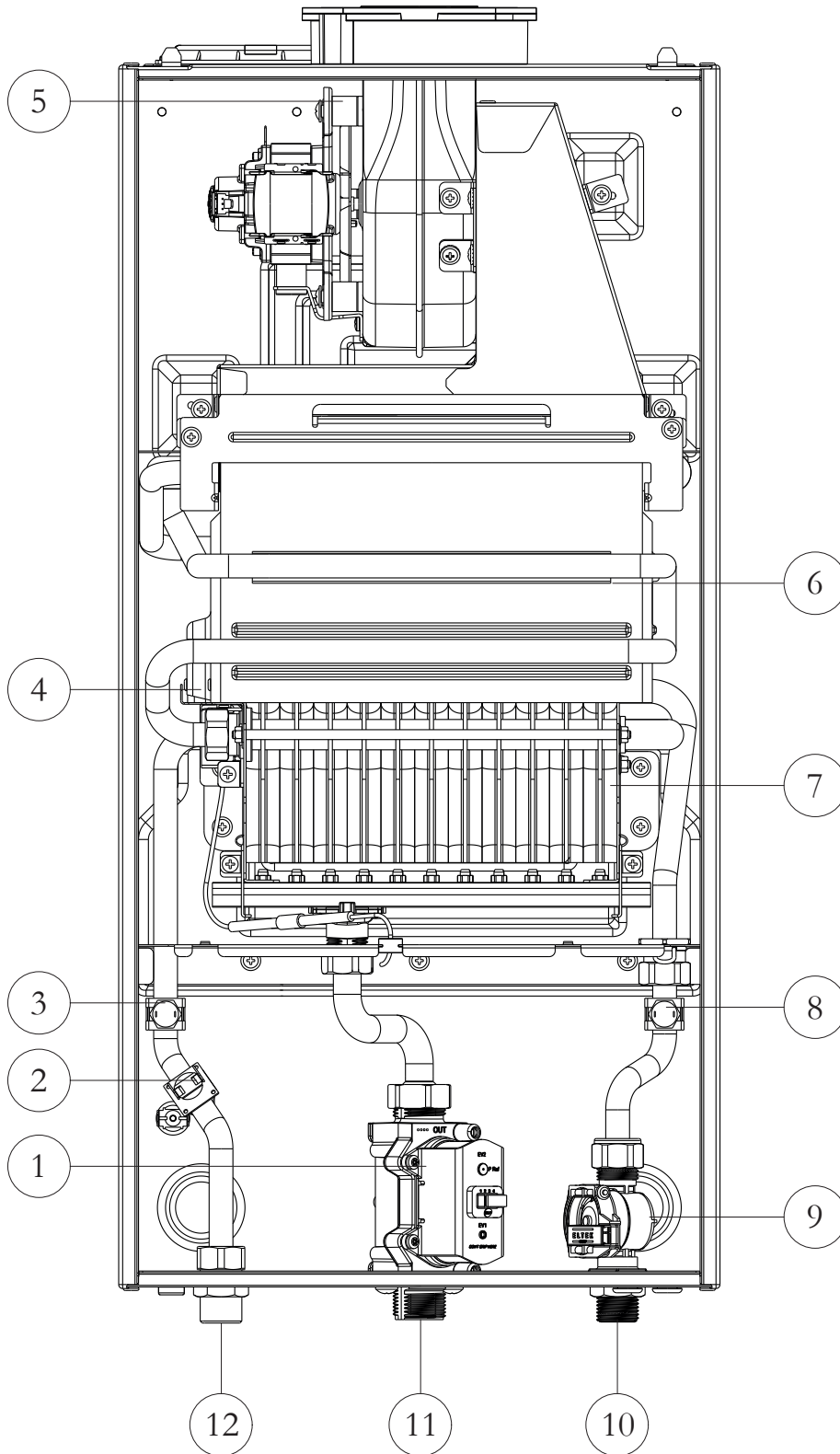

Key:

- |                                  |                                   |
|----------------------------------|-----------------------------------|
| 1 - Gas valve                    | 7 - Burner                        |
| 2 - Limit thermostat             | 8 - NTC probe (cold water intake) |
| 3 - NTC probe (hot water outlet) | 9 - Flow meter                    |
| 4 - Ignition/detection electrode | 10 - Cold water inlet             |
| 5 - Fan                          | 11 - Gas                          |
| 6 - Heat exchanger               | 12 - Hot water outlet             |

## 2 INSTRUCTIONS FOR USE AND MAINTENANCE.

### 2.1 CLEANING AND MAINTENANCE.

**Attention:** to preserve the water heater's integrity and keep its safety features, performance and reliability unchanged over time, maintenance operations must be carried out on a yearly basis in compliance with that stated in the "annual check and maintenance of the appliance" section, in compliance with national, regional, or local standards in force.

### 2.2 GENERAL WARNINGS.

Never expose the wall-mounted water heater to direct vapours from a cooking surface.

The device can be used by children at least 8 years old as well as by persons with reduced physical, sensory or mental capabilities, or lack of experience or required knowledge, provided that they are under surveillance, or after they have been instructed relating to the safe use and have understood the potential dangers. Children must not play with the appliance. Cleaning and maintenance destined to be performed by the user can not be carried out by unsupervised children. Do not touch the flue gas exhaust terminal (if present) due to the high temperatures it can reach.

For safety purposes, check that the concentric air intake/flue exhaust terminal (if fitted), is not blocked.

Whenever temporary deactivation of the water heater is decided, the electric, water and gas supplies must be interrupted.

**N.B.:** you must leave the water heater powered if the optional antifreeze kit is installed and the room temperature can drop below 0°C.

In the case of work or maintenance to structures located in the vicinity of ducting or devices for flue extraction and relative accessories, switch off the appliance and on completion of operations ensure that a qualified technician checks efficiency of the ducting or other devices.

Never clean the appliance or connected parts with easily flammable substances.

Never leave containers or flammable substances in the same environment as the appliance

- It is prohibited to obstruct the air intake and aeration grids where the appliance is installed.

- If there is a water leak, immediately close the mains water supply and ask an authorised company for assistance (for example, Authorised After-sales Service).

• **Attention:** using any components that use electrical power requires some fundamental rules to be observed:

- do not touch the appliance with wet or moist parts of the body; do not touch it when bare-foot;

- never pull electrical cables or leave the appliance exposed to atmospheric agents (rain, sunlight, etc.);

- the appliance power cable must not be replaced by the user;

- in the event of damage to the cable, switch off the appliance and contact exclusively qualified staff for replacement;

- if the appliance is not to be used for a certain period, disconnect the main power switch.

**N.B.:** you must leave the water heater powered if the optional antifreeze kit is installed and the room temperature can drop below 0°C.

At the end of its service life, the appliance must not be disposed of like normal household waste nor abandoned in the environment, but must be removed by a professionally authorised company. Contact the manufacturer for disposal instructions.

### 2.3 QUICK APPLIANCE OPERATION GUIDE.

#### Ignition

Press the ignition button (⏻).

#### Regulation of the water temperature

Turn the regulation knob to the right to increase the temperature and to the left to decrease it (temperature ranging between 37 and 60°C).

#### Switching off

Press and hold the switch-off button (⏻). As soon as the symbols (- -) start flashing, release the button.

The appliance will go OFF and the screen will display the fixed symbols (- -).

#### Reset

Press and hold the reset button (⏻). As soon as the wording (r 5) is displayed, release the button. The appliance is ready for use.

**Attention:** if the appliance is switched off for long periods, disconnect the external omnipolar water heater switch and close the gas cock upstream of the water heater.

**Attention:** if it is likely that the room temperature where the water heater is installed can drop below 0° C, the water inside the water heater must be emptied by closing the cold water inlet cock and opening the hot water cock below the room's main water supply.

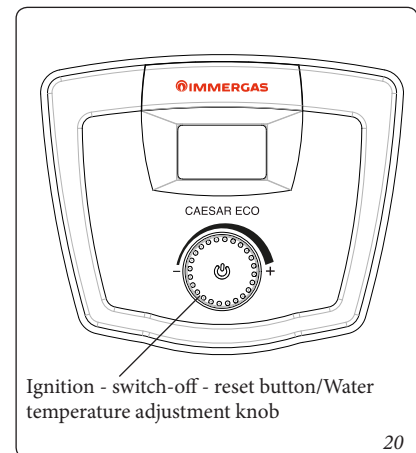

2.4 CONTROL PANEL.

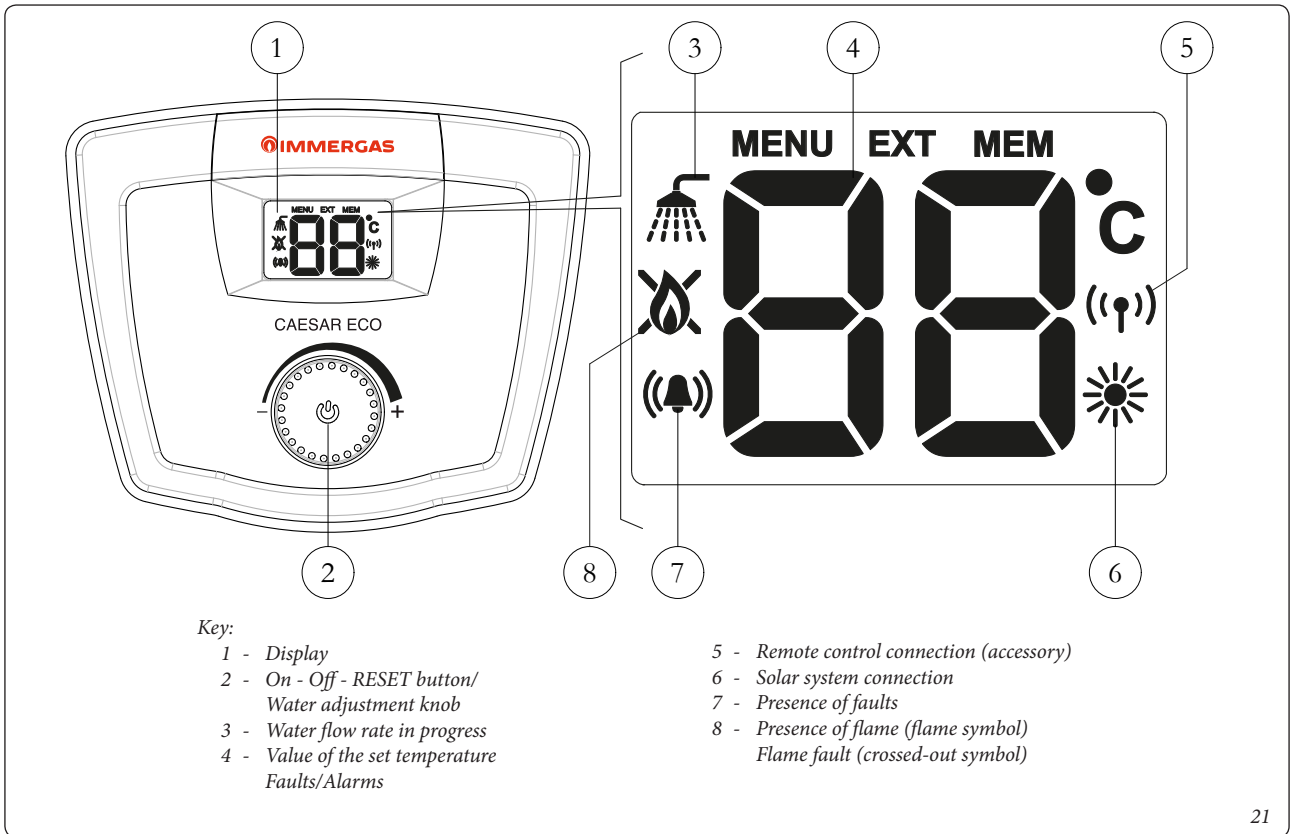

21

2.5 FAULTS AND SCREEN DISPLAYS.

If the appliance blocks, the screen displays the wording (AL) followed by a fault code to refer to in order to release it.

Two types of stops can occur:





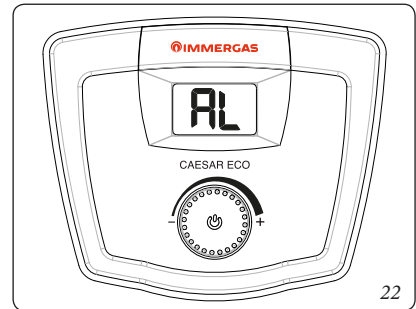

- Temporary stop (not permanent), the fault code flashes, the stop is automatically removed when its cause has been solved. If the fault persists, the temporary stop switches to permanent.

- Definite stop (block), the fault code flashes. In this case, the appliance does not restart automatically and must be released by the user or operator by way of the release procedure only.

Below is a list of the types of alarms, their type of display and the solutions to reset the appliance:



22

Display	Type of alarm	Solutions
 Definite shutdown	Flame control module block alarm. Electronic flame control fault alarm.	Press and hold the reset button (⏻). As soon as the wording (r 5) is displayed, release the button. The appliance restarts automatically (1).
 Definite shutdown	Limit thermostat alarm.	Press and hold the reset button (⏻). As soon as the wording (r 5) is displayed, release the button. The appliance restarts automatically (1).
 Temporary stop	IN-OUT DHW NTC fault alarm.	(1)
 Temporary stop	Parasite flame alarm.	(1)
 Definite shutdown	Modulation coil cable disconnection alarm.	Press and hold the reset button (⏻). As soon as the wording (r 5) is displayed, release the button. The appliance restarts automatically (1).
 Definite shutdown	Alarm in the event of 5 consecutive resets.	To reset the appliance, disconnect and connect it again. Press and hold the reset button (⏻). As soon as the wording (r 5) is displayed, release the button. The appliance restarts automatically (1).
 Temporary stop	Low Voltage alarm.	Wait for the water heater to auto reset (1).

(1) If the shutdown or fault persists, contact an authorised company (e.g. Authorised Technical After-Sales Service)

Display	Type of alarm	Solutions
(40) Temporary stop	Incorrect network frequency detection alarm.	Wait for the water heater to auto reset (1).
(41) Definite shutdown	Flame loss alarm for more than 3 consecutive times.	(1)
(42) Temporary stop	Button fault.	It is displayed when the button is held for over 30 seconds; once released, the fault disappears.
(62) Definite shutdown	Valve calibration request.	(1)
(AL70) Temporary stop	AL70 - Inlet temperature alarm >70°C Displayed with a flashing bell only Complete view is only displayed in the alarms log	(1)
(72) Definite shutdown	Alarm regarding increased temperature not reached.	(1)
(80) Definite shutdown	Driver error alarm.	(1)
(81) Definite shutdown	Alarm caused by a problem with combustion during ignition.	Press and hold the reset button (⏻). As soon as the wording (r 5) is displayed, release the button. The appliance restarts automatically (1).
(82) Definite shutdown	Block caused by persistent bad combustion.	(1)
(83) Temporary stop	Bad combustion alarm.	(1)
(AL84) Temporary stop	AL84 - Bad combustion alarm Displayed with a flashing flame only Complete view is only displayed in the alarms log.	(1)
(86) Definite shutdown	Fan revs sensor alarm.	(1)
(88°C) Display	High temperatures.	(1)
(98) Definite shutdown	Software, startup board error alarm.	(1)
(1) If the shutdown or fault persists, contact an authorised company (e.g. Authorised Technical After-Sales Service)		

## 2.6 EMPTYING THE WATER HEATER.

To empty the water heater, close the cold water inlet valve and open the hot water valve lower down in the water network in the room.

## 2.7 ANTI-FREEZE PROTECTION (OPTIONAL).

The water heater can be equipped with an optional antifreeze kit to protect it against freezing down to outdoor temperatures of -15°C. To install the kit correctly and, more importantly, to ensure suitable operation, it is necessary to follow the instructions supplied with the said kit.

## 2.8 CLEANING THE CASE.

Use damp cloths and neutral detergent to clean the water heater casing. Never use abrasive or powder detergents.

## 2.9 DECOMMISSIONING.

In the event of permanent shutdown of the water heater, contact professional staff for the procedures and ensure that the electrical, water and gas supply lines are shut off and disconnected.

## 2.10 GAS SYSTEM NOT USED FOR PERIODS OVER 12 MONTHS.

The current regulation provides that gas systems not used for over 12 months must be checked prior to being used again, as per regulations in force, by professionally qualified staff.

If the inspection is successful, the water heater can be recommissioned according to the instructions specified in *Paragraph 1.17* herein.

### 3 CHECK AND MAINTENANCE.

#### 3.1 HYDRAULIC DIAGRAM.

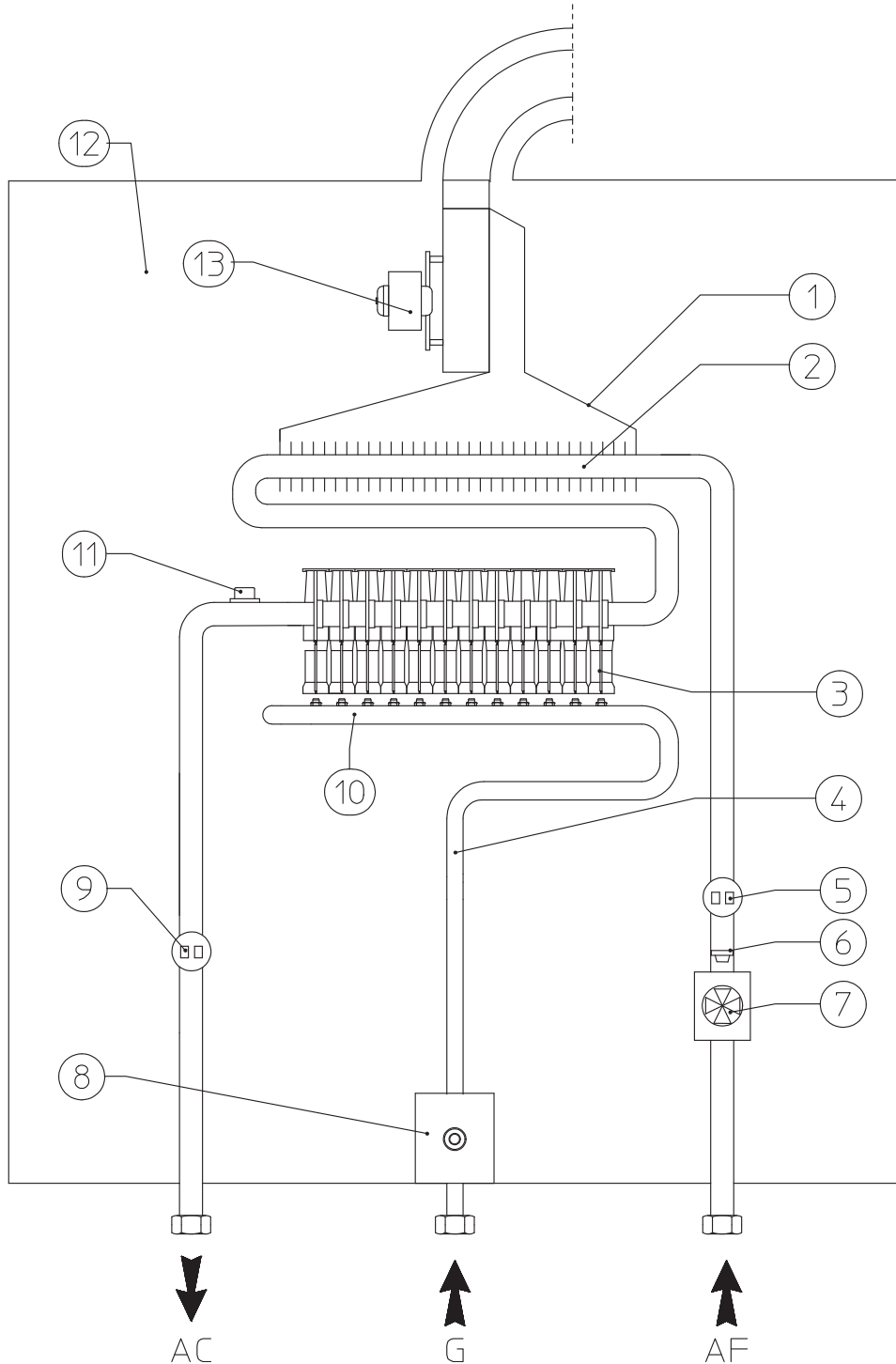

- Key:
- |                                       |                                  |
|---------------------------------------|----------------------------------|
| 1 - Flue hood                         | 9 - NTC probe (hot water outlet) |
| 2 - Domestic hot water heat exchanger | 10 - Nozzle manifold unit        |
| 3 - Burner                            | 11 - Limit thermostat            |
| 4 - Valve/burner pipe                 | 12 - Sealed chamber              |
| 5 - NTC probe (cold water intake)     | 13 - Fan                         |
| 6 - Flow regulator                    | AC - Domestic hot water outlet   |
| 7 - Flow meter                        | AF - Domestic cold water inlet   |
| 8 - Gas valve                         | G - Gas supply                   |

3.2 WIRING DIAGRAM.

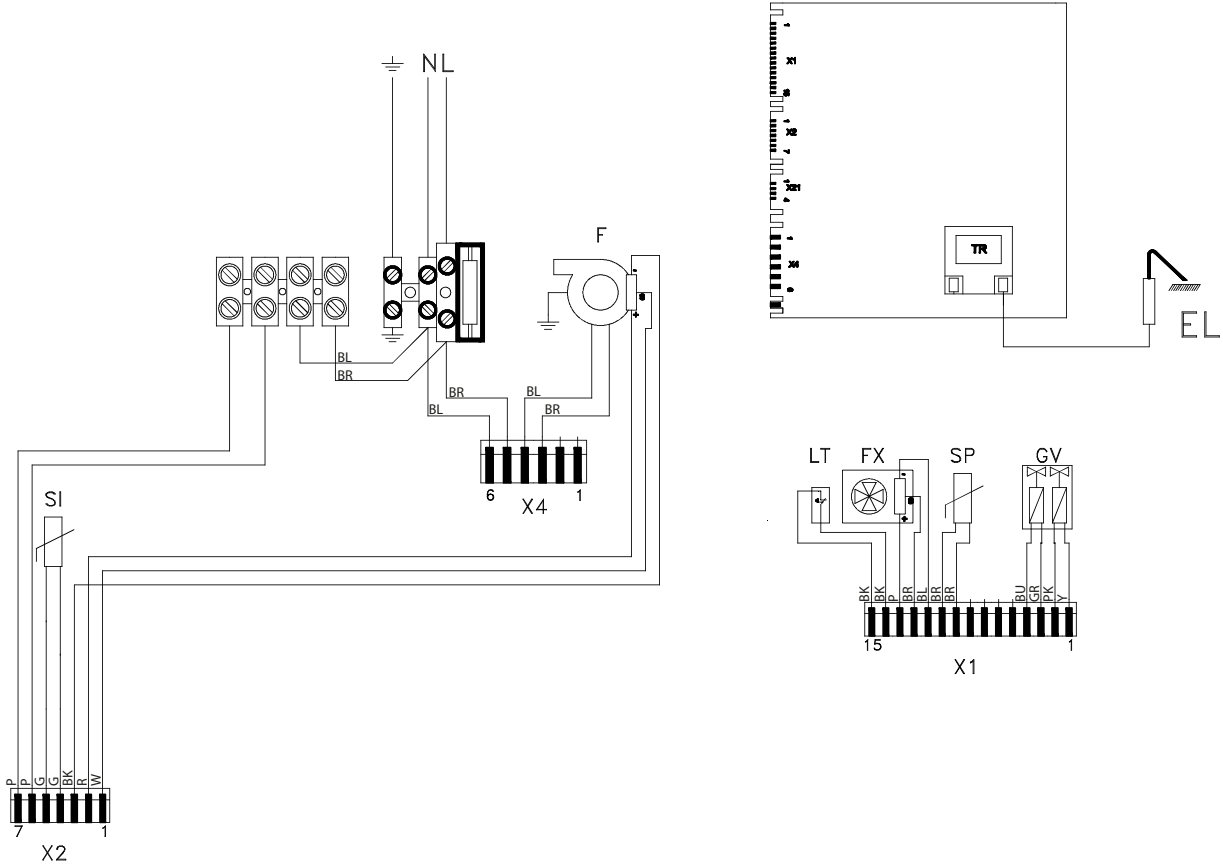

- Key:**
- EL - Ignition electrode
  - TR - Ignition transformer
  - F - Fan
  - FX - DHW flow meter
  - LT - Limit thermostat
  - SP - DHW probe (hot water output)
  - GV - Gas valve
  - YES - DHW probe (cold water input)

- Colour code key:**
- BK - Black
  - BL - Blue
  - BR - Brown
  - G - Green
  - GY - Grey
  - R - Red
  - W - White
  - Y - Yellow
  - P - Purple
  - PK - Pink
  - BU - Light blue

INSTALLER

USER

MAINTENANCE TECHNICIAN



### 3.3 SERVICE MENU.

#### “Service Menu” activation

It is possible to access the “SERVICE MENU” in order to edit the operating parameters of the appliance.

- With the water heater on, press the reset button (⏻) (Fig. 23) for approximately 10 seconds. The symbols on the display will start flashing and first ( \_ ) will be displayed, followed by (00);
- release the reset button;
- enter the code (05) by turning the knob and confirm by pressing reset.

If the code is wrong, or if the time envisaged for the operation should drop, the appliance automatically goes back to the standby or operation status.

Upon accessing the “SERVICE MENU”, it is possible to select the sub-menu concerned by turning the knob:

- (E5) Parameters menu.
- (E8) Calibration menu.
- (AL) Alarms log menu.
- (i) Info menu.

Once you have found the sub-menu you are looking for, confirm by pressing reset (⏻).

**Attention:** to exit from the “SERVICE MENU”, press the reset button until the wording MENU flashes, then release the button: the display goes to the last sub-menu selected. Press the reset button again until the wording MENU flashes, then release the button: the screen displays the value of the set temperature.

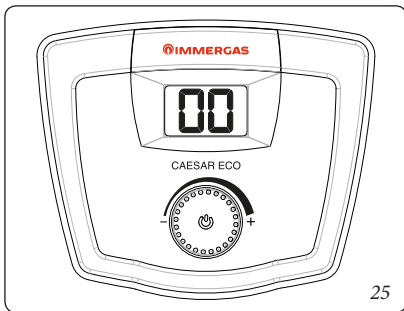

#### Parameters menu (E5)

On activating the menu, the index of the first parameter is displayed, followed by the set value:

- turn the knob to display the following parameters;
- having identified the parameter to edit, press reset: the value that can be edited flashes and, by turning the knob, it is possible to change it;
- save the value by pressing the reset button.

**Attention:** the menu is exited automatically after 5 minutes of inactivity, or by pressing the reset button for a while.

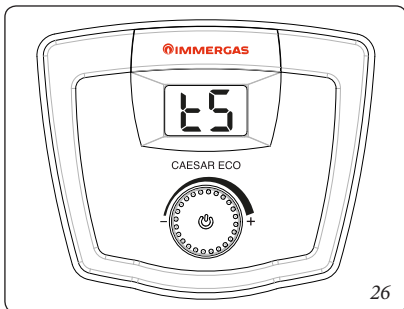

#### Calibration menu (E8)

**Attention:** the pressure must only be adjusted by an authorised technician.

**Attention:** the operations described below must be carried out in sequence.

**Attention:** calibration is completed automatically after 15 minutes of inactivity or by pressing reset for a long time, or in the event of overheating (67°C).

Before calibration, check the network pressure by referring to the previous paragraph.

Two calibration methods are possible for the gas valve:

- **MANU.** Enables a partial modification of the values; it will be possible to deviate from the set value by about +/- 1.5 mbar.
- **AUTO.** Enables to reset the values and perform a complete calibration of the gas valve (e.g.: after replacing the valve, the board or following a gas transformation).

The standard procedure is MANU.

The AUTO procedure can only be accessed by the Authorised Assistance Technical Service (Ref. Par. 3.5).

To access the MANU procedure, proceed as follows:

- set the system's electric switch Off;
- remove the casing by loosening the fastening screws situated in the lower part of the water heater and release the casing from the upper part;
- remove the cap that closes the service passage (situated on the bracket - Fig. 35) and make it pass through the hole of the silicone pipe of the pressure gauge;
- loosen the pressure point screw downstream of the gas valve by approximately two turns and connect a pressure gauge;
- close the casing properly and set the system's switch On;
- access the calibration menu (E8);
- open the hot water tap and wait for the burner to ignite.

On activation of the menu, the wording **Ma** will appear first, followed by **nu** that makes up the word **Manu** and (P00) to indicate that the appliance is operating at its maximum.

- Turn the knob until the burner's maximum pressure value is displayed on the pressure gauge (ref. technical data table);
- to save the value, press the reset button;
- press the reset button to select the next value regarding minimum calibration (P00);
- turn the knob until the burner's minimum pressure value is displayed on the pressure gauge (ref. technical data table);
- to save the value, press the reset button;
- press the reset button until the word MENU flashes, then release the button: the screen will display (E8);
- press the reset button again until the wording MENU flashes, then release the button: the screen displays the value of the set temperature;
- close the hot water cock.

**Attention:** the menu is exited automatically after 15 minutes of inactivity, or in the event of overheating 67°C).

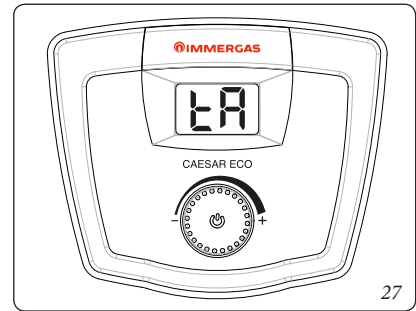

#### Alarms log menu (AL)

This function enables you to view the last 10 errors triggered on the appliance.

On activating the menu, the following is displayed alternately: the wording (E1) (index of the last error memorised), the error code and wording (AL) (e.g.: (E1) => (05) => (AL)).

Turn the knob to scroll through the index of errors; the displays run from the most recent to the furthest in time.

If the user pauses, the screen displays the wording AL to indicate that they are in the errors log menu.

Press the reset button until the wording MENU flashes, then release the button, the screen displays (AL).

**Attention:** to exit the menu, press the reset button again until the wording MENU flashes, then release the button: the screen displays the value of the set temperature.

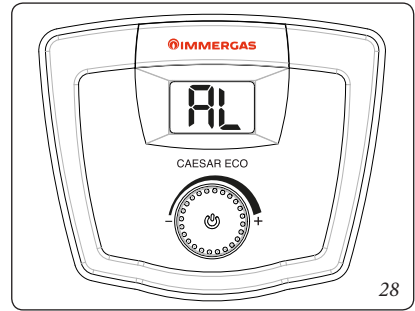

#### Info menu (i)

This function displays:

- the software revision.
- The water temperature in real time.
- The water flow rate in real time (l/min).

This function remains active when supplying hot water.

**Attention:** the menu is exited automatically after 15 minutes of inactivity, or by pressing the reset button.

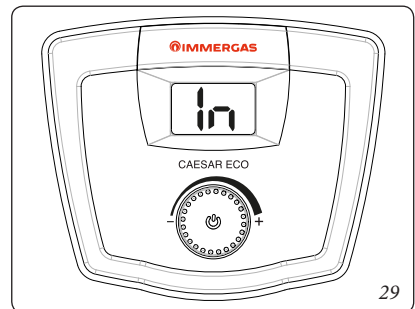

Below is a list of parameters that can be edited.



No. parameter	Description	Range	Default value
02	Gas type 0 = methane 1 = LPG	0-1	depending on the type of gas for which the boiler is set in the factory
08	DHW mode off 0 = fixed 1 = linked to the DHW setpoint	0-1	0
09	Ignition power	0...40	40
10	Ignition curve	0 - 3	1
13	LPG gas type 1 = propane 2 = butane	1-2	depending on the type of gas for which the boiler is set in the factory
17	Complete or partial calibration	0...100	0
18	DHW modulation with flow meter 0 = modulation without flow meter 1 = modulation with flow meter	0-1	1
26	Type of water heater 0 = Caesar Eco 11 1 = Caesar Eco 14 2 = not applicable to this model 3 = not applicable to this model	0...3	depending on the model
27	Modulation coil reactivity	0 - 1	0
28	0 = standard water heater installation from 1 to 20 = solar water heater, start-up delay (in seconds) of the device upon request	0 from 1 to 20	0

**Attention:** any other additional parameters with regard to the previous table must not be changed for any reason.

### 3.4 POSSIBLE PROBLEMS AND THEIR CAUSES.

**N.B.:** maintenance operations must be carried out by an authorised company (e.g. Authorised After-Sales Technical Assistance Service).

Refer to paragraph 2.5 for information regarding faults and display signals.

- Smell of gas. Caused by leakage from gas circuit pipelines. Check tightness of gas intake circuit.
- Irregular combustion (red or yellow flame). Can be caused by: dirty burner, clogged lamellar pack, intake - exhaust terminal not installed properly. Clean the above components and ensure correct installation of the terminal.
- Frequent trips of the overheating temperature or safety thermostat. It can depend on an anomaly on the water heater P.C.B. or and anomaly of the regulation NTC probe.
- Poor water flow: if, as a result of limescale (calcium and magnesium), the domestic hot water system does not work properly contact an authorised company for descaling e.g. Authorised Technical Assistance Service according to good practice. To preserve integrity and efficiency of the heat exchanger, a non corrosive descaler must be used. Cleaning must be carried out without the use of tools which can damage the heat exchanger.

### 3.5 CONVERTING THE WATER HEATER TO OTHER TYPES OF GAS.

The operation of appliance transformation from a gas family to another can be easily carried out even if the appliance is installed.

Instructions regarding the transformation and adjustment of various types of gas are described below.

To transfer to LPG, place the plate on the manifold, as indicated in Fig. 30.

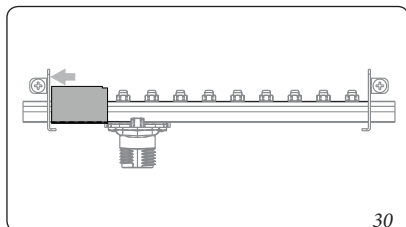

**Attention:** please note that transformation operations must be carried out by professionally authorised and qualified staff, in compliance with the technical regulations in force.

Switch off the device from the omnipolar switch provided on the power supply line and close the gas and water cocks.

- Remove the casing by referring to the specific chapter;
- remove the wire spring placed on the cold water pipe (Part. A Fig. 31);
- disconnect the gas pipe and remove it (Part. B Fig. 31);
- loosen the three screws shown in Fig. 32 lower the intermediate metal-sheet plate (Fig. 33);
- loosen the side fastening screws of the manifold, remove the side brackets and extract the gas manifold (Fig. 34);
- replace the manifold.

**Attention:** the manifold is already equipped with injectors, it is therefore not necessary to replace them.

- Reassemble the components proceeding in reverse order;
- if there are seals, they must be restored.

#### Parameter change 02 (type of gas)

Start the appliance and access the **Parameters menu** (E5), as follows:

- with the water heater on, press the reset button (⏻) for approximately 10 seconds. The symbols on the display will start flashing and first (- -) will be displayed, followed by (00);
- release the reset button;
- enter the code (05) by turning the knob and confirm by pressing reset;
- turn the knob to select (E5) (Parameters menu) and confirm by pressing reset;
- on accessing the Menu, scroll through the list with the knob until finding parameter 02 (gas type), and press reset: the value that can be reset will flash and it will be possible to select the type of gas required by turning the knob: 0 (MTN) - 1 (LPG);
- if LPG gas is selected, propane gas is selected by default. If you require butane gas, set parameter 13 to 2;
- save by pressing the reset button.

After the procedure, the appliance displays alarm AL62, which indicates that you must calibrate the gas valve.

**Attention:** the menu is exited automatically after 5 minutes of inactivity, or by pressing the reset button for a while.

#### Complete gas valve calibration (Accessible ONLY by the Authorised Technical Assistance Service).

To access the **AUTO** procedure, proceed as follows:

- set the system's electric switch Off;
- remove the casing;
- remove the cap that closes the service passage (located on the bracket Fig. 36) and make it pass through the hole of the silicone pipe of the pressure gauge;
- loosen the pressure point screw downstream of the gas valve by approximately two turns (Fig. 36) and connect a pressure gauge;
- close the casing properly;
- set the system's electrical switch to on and open the hot water cock.

Access the **Parameters menu** (E5), as follows:

- with the water heater on, press the reset button (⏻) for approximately 10 seconds. The symbols on the display will start flashing and first (- -) will be displayed, followed by (00);
- release the reset button;
- enter the code (05) by turning the knob and confirm by pressing reset;
- turn the knob to select (E5) (Parameters menu) and confirm by pressing reset;
- on accessing the Menu, scroll through the list with the knob until finding parameter 17 (complete or partial calibration), and press reset: the value that can be reset will flash and it will be possible to select value 5 by turning the knob;
- save by pressing the reset button.

**Attention:** in case of a power failure the procedure must be repeated.

Access the **Calibration menu** (E8) as follows:

- press the reset button (⏻) until the flashing **MENU** and (E5) appear on the display;
- turn the knob to select (E8) (Calibration menu) and confirm by pressing reset;
- **AUTO** and (P00) appear on the display to indicate that the device operates fully;
- Turn the knob until the burner's maximum pressure value is displayed on the pressure gauge (Ref. Parag. 3.10);
- to save the value, press the reset button;
- press the reset button to select the next value regarding minimum calibration (P00);
- Turn the knob until the burner's minimum pressure value is displayed on the pressure gauge (Ref. Parag. 3.10);
- press the reset key;
- Press the reset button (⏻) until **MENU** flashes on the display, then release the button, the screen displays (E8);
- press the reset button again until the wording **MENU** flashes, then release the button: the screen displays the value of the set temperature;
- close the hot water cock.

**Attention:** the menu is exited automatically after 15 minutes of inactivity, or by pressing the reset button for a while.

**Attention:** in case of a power failure the procedure must be repeated.

**Attention:** write on the adhesive plate provided the type of gas in which it was transformed, the date when the transformation was carried out, the name and signature of the operator who made the transformation and then stick it close to the existing plate.

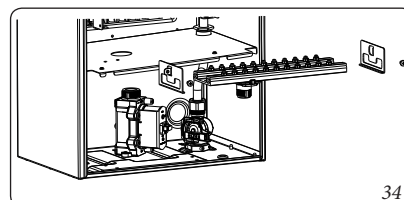
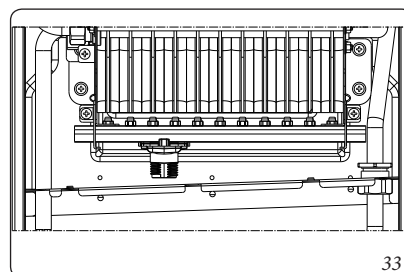
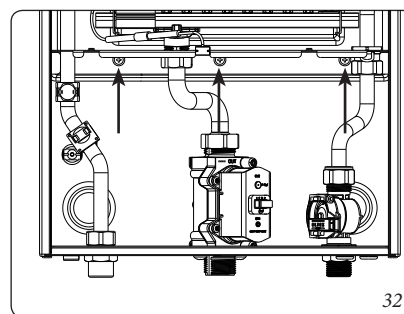
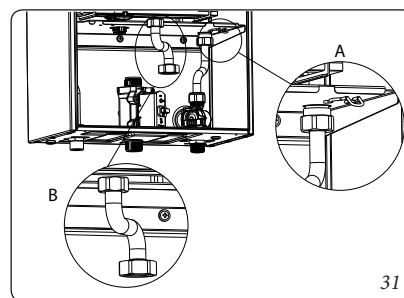

### 3.6 SOLAR PANELS COUPLING FUNCTION.

All Immergas models are supplied as standard with the NTC probe applied to the DHW cold water inlet pipe. The probe can be activated by setting the parameter "P28".

When parameter "P28" is equal to zero the probe is disabled; when instead the parameter is assigned a value between 1 and 20, the probe is enabled and the function is activated with a delay that can be set between 1 and 20 seconds.

The water heater is set up to receive pre-heated water from a system of solar panels up to a maximum temperature of 65°C.

**Attention:** the manufacturer denies any liability for damage to persons or things caused by exceeding this temperature.

In any case, it is always necessary to install a mixing valve on the hydraulic circuit upstream of the boiler, on the cold water inlet. Set the temperature on the mixing valve increased by 5°C with respect to that set on the water heater, so as to ensure that the temperature at the water heater inlet does not exceed the maximum value indicated.

If the temperature detected on the inlet probe is lower than that set by the user with the knob, the water heater switches on and goes into modulation until the desired temperature is reached. On the other hand, if the temperature detected on the inlet probe is close to or equal to that set by the user, the water heater does not switch on.

### 3.7 CHECK THE NETWORK PRESSURE (MINIMUM POWER SUPPLY PRESSURE - ONLY WITH APPLIANCES OPERATING WITH METHANE).

- Disconnect power from the water heater
- remove the casing by loosening the fastening screws situated in the lower part of the water heater and release the casing from the upper part (Fig. 36);
- remove the cap that closes the service passage (situated on the bracket - Fig. 35) and make it pass through the hole of the silicone pipe of the pressure gauge;
- loosen the pressure point screw upstream of the gas valve (Fig. 35) by approximately two turns and connect the pressure gauge;
- close the casing properly;
- turn the water temperature adjustment knob to maximum;
- connect power to the water heater;
- open a hot water tap to the maximum flow rate.

Check the gas pressure by referring to the values indicated in the data table. If the pressure is above 15 mbar, proceed with calibrating the gas valve. When measuring, a tolerance of +/- 0.5 mbar is permitted.

- Close the hot water cock;
- disconnect the pressure gauge and secure the pressure point screw upstream of the gas valve again;
- if there are seals, they must be restored.

### 3.8 YEARLY APPLIANCE CHECK AND MAINTENANCE.

The following checks and maintenance should be performed at least once a year.

- Clean the flue side of the heat exchanger.
- Clean the main burner.
- Visually check the flue hood for deterioration or corrosion.
- Check correct lighting and functioning.
- Check correct burner calibration.
- Check correct operation of control and adjustment devices of the appliance. and in particular:
  - the intervention of the functioning selector positioned on the water heater control panel;
  - domestic hot water control thermostat intervention.
- Check that the internal system is properly sealed according to the specifications set forth by technical regulations in force.
- Check the intervention of the device against no gas ionisation flame control. Intervention time must be less than 10 seconds.
- Check for water leaks or oxidation from/on the fittings.
- Visually check that the safety and control devices have not been tampered with and/or shorted, in particular:
  - temperature safety thermostat;
- Check the condition and integrity of the electrical system and in particular:
  - the power cables must be inside the cable fixings;
  - there must be no traces of blackening or burning.

INSTALLER

USER

MAINTENANCE TECHNICIAN

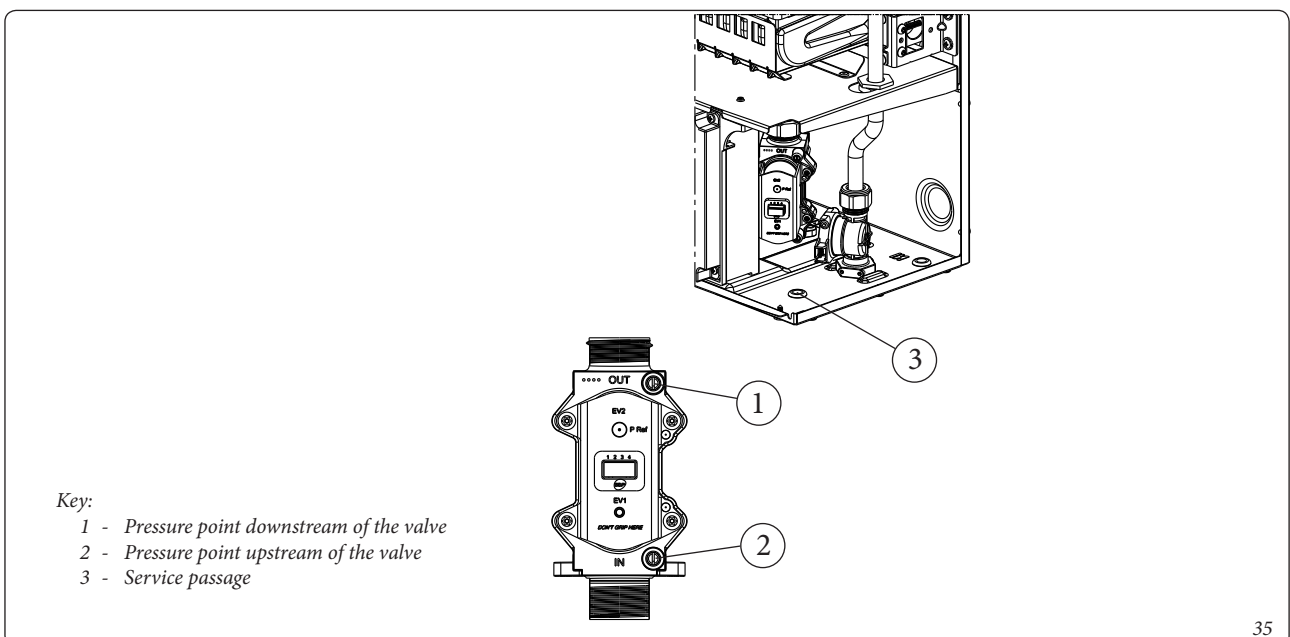

### 3.9 CASING REMOVAL.

To facilitate water heater maintenance, the casing can be completely removed by following these simple instructions (Fig. 36):

- 1) Loosen the lower screws (a) that secure the casing (b).
- 2) Pull the casing towards you (b) in the lower side.
- 3) Push the casing (b) upwards in a way to be able to extract it from the upper hooks (c).

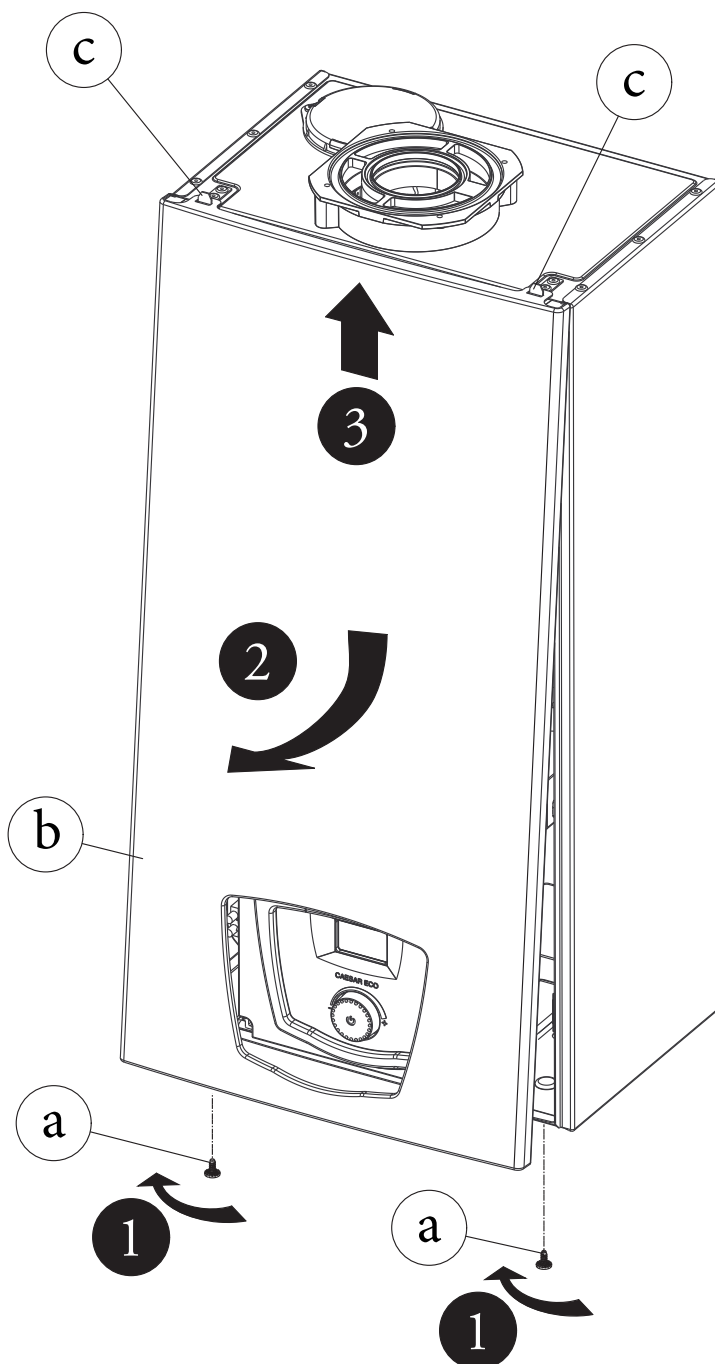

### 3.10 COMBUSTION PARAMETERS.

		<b>G20</b>	<b>G30</b>	<b>G31</b>
Supply pressure	mbar	20	28-30	37
<b>Caesar Eco 11</b>				
Diameter of the main burner nozzle (No. of nozzles) (*)	mm	0,86 (18) + 0,83 (4)	0,50 (18) + 0,48 (4)	0,50 (18) + 0,48 (4)
Nozzles (*)	N.	22	22	22
P.C.I. (15° C 1013 mbar)	MJ/m <sup>3</sup>	34,02	116,09	88
WI (15° C 1013 mbar)	MJ/m <sup>3</sup>	45,67	80,58	70,69
Consumption	m <sup>3</sup> /h	2,28	-	-
	kg/h	-	1,70	1,67
Max./min. burner pressure	mbar	11,70 - 2,60	28,30 - 6,10	36,40 - 8,00
Min./max. flue flow rate at max heat output	kg/h	39,308 - 60,035	42,465 - 57,527	43,379 - 49,379
Flue temperature at min./max. output	°C	101 - 160	101 - 165	96 - 159
Emissions of nitrogen oxides (NOx)	mg/kWh	35,00	60,00	45,00
Air flow rate	Nm <sup>3</sup> /h	46,315	44,359	37,911
<b>Caesar Eco 14</b>				
Diameter of the main burner nozzle (No. of nozzles) (*)	mm	0,86 (24) + 0,83 (4)	0,50 (24) + 0,48 (4)	0,50 (24) + 0,48 (4)
Nozzles (*)	N.	28	28	28
P.C.I. (15° C 1013 mbar)	MJ/m <sup>3</sup>	34,02	116,09	88
WI (15° C 1013 mbar)	MJ/m <sup>3</sup>	45,67	80,58	70,69
Consumption	m <sup>3</sup> /h	2,86	-	-
	kg/h	-	2,13	2,10
Max./min. burner pressure	mbar	12,40 - 2,00	28,20 - 4,40	36,00 - 5,60
Min./max. flue flow rate at max heat output	kg/h	40,233 - 66,526	45,936 - 73,412	38,273 - 62,873
Flue temperature at min./max. output	°C	90 - 177	95 - 177	91 - 174
Emissions of nitrogen oxides (NOx)	mg/kWh	29,00	45,00	21,00
Air flow rate	Nm <sup>3</sup> /h	51,262	56,620	48,280

(\*): it is strictly forbidden to replace the nozzles individually. If necessary, replace the entire manifold.

### 3.11 TECHNICAL DATA.

		<b>Caesar Eco 11</b>	<b>Caesar Eco 14</b>
Nominal heat input (Qn)	kW (kcal/h)	21,5 (18490)	27,0 (23220)
Minimum heat input (Qm)	kW (kcal/h)	9,5 (8170)	10,0 (8600)
Nominal heat output (useful) (Pn)	kW (kcal/h)	19,3 (16600)	24,3 (20900)
Minimum heat output (useful) (Pm)	kW (kcal/h)	8,6 (7400)	9,0 (7740)
Domestic hot water flow limiter	l/min	8	10
Flow rate capacity in continuous duty (ΔT 35°C)	l/min	8	10
Minimum water flow rate ignition	l/min	2	2
Domestic hot water adjustable temperature	°C	37 - 60	37 - 60
Minimum water pressure	bar	0,13	0,13
Maximum water pressure	bar	10	10
Water heater weight	kg	14	16
Fan residual head without pipes	Pa	72	90
Electrical connection	V/Hz	230/50	230/50
Installed electric power	W	41	59
Equipment electrical system protection	-	IPX5D	IPX5D
Type of appliance	B22 / B22P / B32 / C12 / C12x / C32 / C32x / C42 / C42x / C52 / C52x / C62 / C62x / C82 / C82x		
Category	II2R3R		

- The data relevant to domestic hot water performance refer to a dynamic inlet pressure of 2 bar and an inlet temperature of 15°C; the values are measured directly at the water heater outlet considering that to obtain the data declared mixing with cold water is necessary.

3.12 PRODUCT FICHE (IN COMPLIANCE WITH REGULATION 812/2013).

Caesar Eco 11

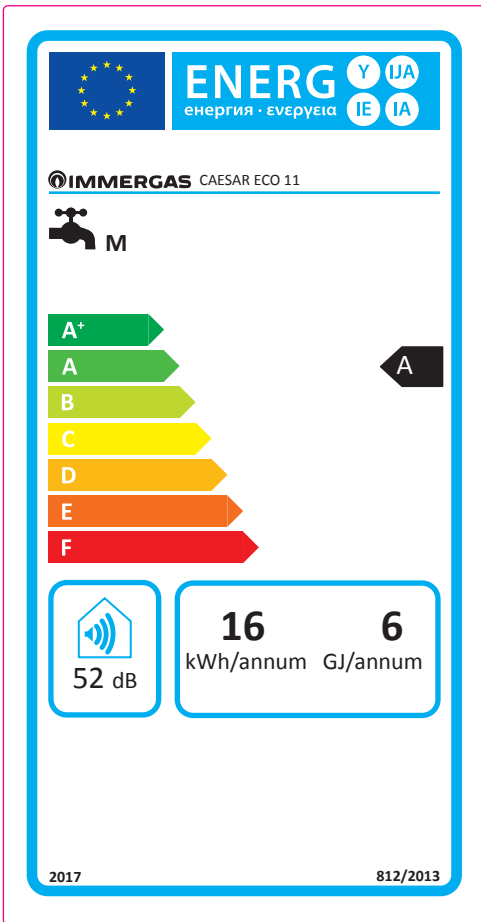

Parameter	value
Annual electricity consumption for the domestic hot water function (AEC)	16 kWh
Annual fuel consumption for the domestic hot water function (AFC)	6 GJ
Water heating energy efficiency ( $\eta_{wh}$ )	71 %

Caesar Eco 14

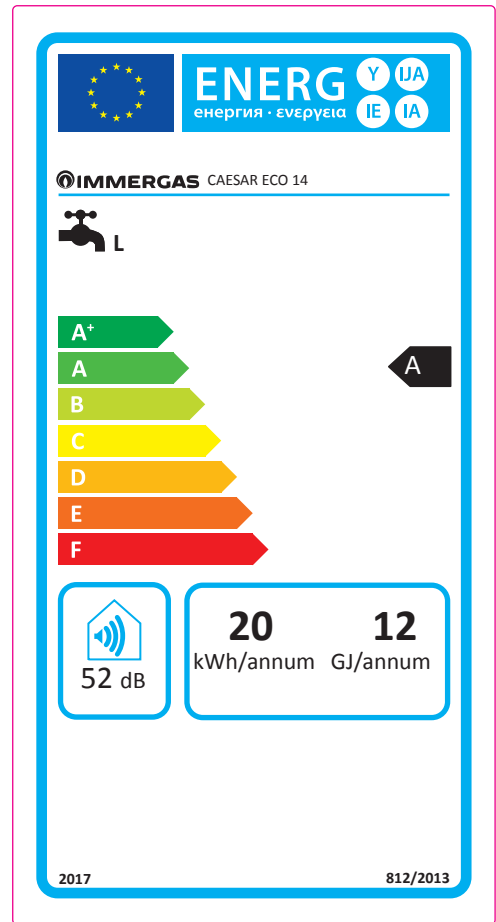

Parameter	value
Annual electricity consumption for the domestic hot water function (AEC)	20 kWh
Annual fuel consumption for the domestic hot water function (AFC)	12 GJ
Water heating energy efficiency ( $\eta_{wh}$ )	77 %

For proper installation of the appliance refer to *Chapter 1* of this booklet (for the installer) and current installation regulations. For proper maintenance, refer to *Chapter 3* of this booklet (for the maintenance technician) and adhere to the frequencies and methods set out herein.

### 3.13 PARAMETERS FOR FILLING IN THE PACKAGE FICHE.

Should you wish to install an assembly, starting from the Caesar Eco 11 or Caesar Eco 14 water heater, use the package fiche in Fig. 39.

To complete it properly, fill the relevant spaces (as shown in the assembly sheet facsimile Fig. 37) with the values shown in tables Fig. 38.

The remaining values must be obtained from the technical data sheets of the products used to make up the assembly (e.g. solar devices, integration heat pumps, temperature controllers). Use board Fig. 39 for “assemblies” related to the domestic hot water function (e.g.: water heater + solar thermal system).

#### Facsimile for filling in the domestic hot water production system package fiche.

Water heating energy efficiency of the water heater

<sup>1</sup>  
 %

Stated load profile:

Solar contribution

From the board of the solar device

Auxiliary electricity

$$(1.1 \times 'I' - 10\%) \times 'II' - 'III' - 'I' = + \text{} \%$$

Water heating energy efficiency of the assembly in average climate conditions

<sup>3</sup>  
 %

Water heating energy efficiency class of the assembly in average climate conditions

	<input type="checkbox"/>	<input type="checkbox"/>	<input type="checkbox"/>	<input type="checkbox"/>	<input type="checkbox"/>	<input type="checkbox"/>	<input type="checkbox"/>	<input type="checkbox"/>	<input type="checkbox"/>	<input type="checkbox"/>
	G	F	E	D	C	B	A	A <sup>+</sup>	A <sup>++</sup>	A <sup>+++</sup>
<input type="checkbox"/> M	< 27 %	≥ 27 %	≥ 30 %	≥ 33 %	≥ 36 %	≥ 39 %	≥ 65 %	≥ 100 %	≥ 130 %	≥ 163 %
<input type="checkbox"/> L	< 27 %	≥ 27 %	≥ 30 %	≥ 34 %	≥ 37 %	≥ 50 %	≥ 75 %	≥ 115 %	≥ 150 %	≥ 188 %
<input type="checkbox"/> XL	< 27 %	≥ 27 %	≥ 30 %	≥ 35 %	≥ 38 %	≥ 55 %	≥ 80 %	≥ 123 %	≥ 160 %	≥ 200 %
<input type="checkbox"/> XXL	< 28 %	≥ 28 %	≥ 32 %	≥ 36 %	≥ 40 %	≥ 60 %	≥ 85 %	≥ 131 %	≥ 170 %	≥ 213 %

Water heating energy efficiency class in colder and hotter climate conditions

Colder: <sup>3</sup> 0.2 x <sup>2</sup> =  %

Hotter: <sup>3</sup> 0.4 x <sup>2</sup> =  %

*The energy efficiency of the set of products indicated in this sheet may not reflect the actual energy efficiency after installation since such efficiency is affected by additional factors, such as the heat loss in the distribution system and the size of the products compared to the size and features of the building.*

Parameters for filling in the DHW package fiche.

Parameter	Caesar Eco 11	Caesar Eco 14
'I'	69	86
'II'	*	*
'III'	*	*

\* to be determined according to Regulation 812/2013 and transient calculation methods as per Notice of the European Community no. 207/2014.

38

Domestic hot water production system package fiche.

Water heating energy efficiency of the water heater ①  %

Stated load profile:

---

Solar contribution

From the board of the solar device

Auxiliary electricity  
↓

( 1.1 x  - 10% ) x  -  -  = + ②  %

---

Water heating energy efficiency of the assembly in average climate conditions ③  %

---

Water heating energy efficiency class of the assembly in average climate conditions

**G** **F** **E** **D** **C** **B** **A** **A+** **A++** **A+++**

<input type="checkbox"/>	<b>M</b>	< 27 %	≥ 27 %	≥ 30 %	≥ 33 %	≥ 36 %	≥ 39 %	≥ 65 %	≥ 100 %	≥ 130 %	≥ 163 %
<input type="checkbox"/>	<b>L</b>	< 27 %	≥ 27 %	≥ 30 %	≥ 34 %	≥ 37 %	≥ 50 %	≥ 75 %	≥ 115 %	≥ 150 %	≥ 188 %
<input type="checkbox"/>	<b>XL</b>	< 27 %	≥ 27 %	≥ 30 %	≥ 35 %	≥ 38 %	≥ 55 %	≥ 80 %	≥ 123 %	≥ 160 %	≥ 200 %
<input type="checkbox"/>	<b>XXL</b>	< 28 %	≥ 28 %	≥ 32 %	≥ 36 %	≥ 40 %	≥ 60 %	≥ 85 %	≥ 131 %	≥ 170 %	≥ 213 %

Water heating energy efficiency class in colder and hotter climate conditions

Colder: ③  0.2 x ②  =  %

Hotter: ③  0.4 x ②  =  %

---

*The energy efficiency of the set of products indicated in this sheet may not reflect the actual energy efficiency after installation since such efficiency is affected by additional factors, such as the heat loss in the distribution system and the size of the products compared to the size and features of the building.*

39













[immergas.com](http://immergas.com)

Immergas S.p.A.  
42041 Brescello (RE) - Italy  
Tel. 0522.689011  
Fax 0522.680617

**Certified company ISO 9001**

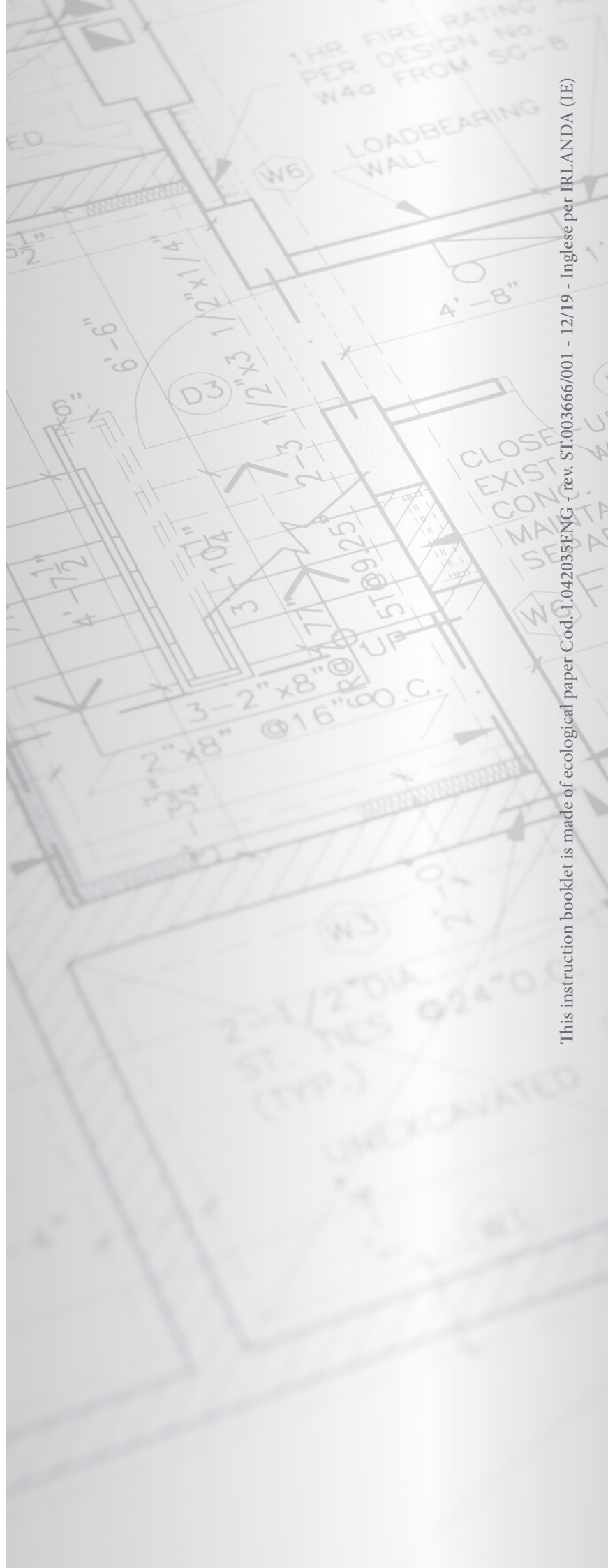

This instruction booklet is made of ecological paper Cod. I.042035ENG - rev. ST.003666/001 - 12/19 - Inglese per IRLANDA (IE)