



NEW

MAGIS M TOP

Monobloc heat pump
with R290 refrigerant gas

Advanced cooling/heating
solution for residential
buildings and installation
without F-Gas patent.



MAGIS M TOP

High efficiency and eco-friendly with R290

The new Immergas monobloc air/water heat pump **designed to guarantee maximum efficiency and sustainability thanks to the use of the natural refrigerant gas R290.**

Available in 6 versions (4 single-phase and 2 three-phase "T") with power from 5 kW to 16 kW, it is **ideal for new residential buildings and existing ones**, thanks to the high energy performance of R290 and the wide operating range (system flow temperature up to 75 °C) which **allow operation even on systems with high-temperature emitters (radiators and fan coils).**

MAGIS M TOP can be installed individually or in series on centralized systems, covering the functions of heating, cooling and domestic hot water production.

Hermetically sealed product, **it does not require the F-Gas patent for installation**, simplifying connections and installation.

MAGIS M TOP range meets the requirements of European directives on new and existing building energy use, aim to improve energy efficiency and reduce carbon emissions.



R290

Green and efficient gas

Natural refrigerant gas composed of carbon and hydrogen.

Thanks to its ecological characteristics and high features, it is **one of the most promising alternatives for a sustainable future**, helping to reduce the environmental impact without compromising its performance.

Eco-friendly

R290 has a very low global warming potential (GWP=0,02), making it an eco-friendly choice compared to synthetic refrigerants with a higher GWP. It does not damage the ozone layer, with an ozone depletion potential (ODP) of zero.

Energy efficiency

Known for its high thermal efficiency, this gas allows for better performance in terms of energy consumption compared to other refrigerants.

Naturalness

Because it is a natural gas, it is easily available and has a lower environmental impact during its production and life cycle.

Safety

Although R290 is a flammable gas, the refrigeration systems that use it, are designed to minimize risks. International regulations set strict limits on the amount of gas that can be used and the safe conditions in which the systems operate.





NEXIS, WIRED REMOTE PANEL, AS STANDARD

NEXIS is the user interface designed to manage and optimize the operation of MAGIS M TOP. With a refined design and black color, it is equipped with a 4.3" TFT color display that guarantees a clear and bright visual output superior to traditional LCD. The six backlit touch keys are functional even in low light conditions.

NEXIS is also a chronothermostat and an intelligent sensor capable of detecting temperature and humidity, for customized comfort at all times.



IMMER Comfort



Alexa and
Google Home
compatible

REMOTELY MANAGEMENT MAGIS M TOP

By means Gateway Wi-Fi V2 option kit, **it is possible to remotely manage the heat pump via app or dedicated web portal.**

Main functions:

- management of the system status and operating calendars
- management of each system zone, temperature and time slots
- pop-up notifications for error reporting and software update

Each user can also monitor the data of their system:

- temperature and domestic water set point
- specific data of the various zones (set point, actual temperature, humidity, active alarms)

E-BOX TOP, AS STANDARD

The box contains the electronic board for system management.

Indispensable for configuring the system parameters, it communicates via Modbus protocol with the MAGIS M TOP heat pump and with the NEXIS wired control panel.

The installation of E-BOX TOP, inside the building, is necessary for managing different system configurations and related components, such as probes, circulators, three-way valves, integrative resistances, etc.

It also allows the control of electronics and thermoregulation (including control panel, gateway V2, additional devices, etc.).

GATEWAY WI-FI V2, OPTION

It must be connected via Modbus to the E-BOX TOP which is supplied as standard with MAGIS M TOP.





GREEN TECH CENTER

The new Innovation Center

Research, Innovation, Training are the key elements of Immergas investments.

A big step towards innovation and sustainability has been taken with the recent construction of a new building dedicated to the research and development of appliances that take advantage of renewable energy sources with the aim of contributing to global efforts to reduce emissions and promote green energy.

RESEARCH AND DEVELOPMENT LABORATORIES

Engineers and experts will have advanced laboratories for research on eco-friendly sources, to open up to new great possibilities and keep the company at the forefront of sustainable solutions.

CONSTANT INNOVATION

With this new asset within our headquarters we can anticipate the market, in compliance with the increasingly green regulations in terms of consumption and emissions, to be points of reference in innovation and sustainability.

TRAINING SPACES

The new Innovation Center will host training rooms to provide high-level training to HVAC engineers and technicians, continuing our idea of excellence.





MAGIS M TOP

Maximum efficiency and sustainability with R290

INVESTING IN YOUR FUTURE

This innovative range represents an important step in the technological evolution of the company, the result of significant investments in production and the creation of a dedicated line. MAGIS M TOP is in fact the first series of heat pumps assembled and tested at the Immergas plant in Brescello.

ELEGANT DESIGN

Dirk Schumann, the designer who has been working alongside Immergas for over twenty years, has characterized the new MAGIS M TOP with a grille with a refined design, thin lines and an angled contour to facilitate the flow of air and hide the internal mechanics of the fan. Dark grey RAL 7030.

EFFICIENT AND SILENT SOLUTIONS

The high energy classes of the new range of MAGIS M TOP monobloc heat pumps guarantee very low electrical absorption and energy consumption. The "inverter" technology further increases the performance of the machines, especially in the mid-seasons when the energy requirements are lower. The single fan and the Silent Mode function provide significant benefits, ensuring quiet operation.

Heating and cooling operation
(reversible)

Hermetically sealed R290 refrigerant gas circuit (GWP=0,02)

Max flow temperature C.H. 75 °C and D.H.W. 65 °C (without integration)

Silent operation: 35 dB (A)

Protection rating IPX4 (approved for fully exposed outdoor installation)

Energetic class in heating
A+++ LT (35 °C), A++ MT (55 °C)

Can be installed individually, in series and **in combination with Immergas boiler using system controller kit**



Refrigerant circuit equipped with inverter compressor (Rotary for versions 5–8 and Scroll for versions 12–16), electronic lamination valve, 4-way reversing valve, high and low pressure switches

Hydronic circuit as standard: circulation pump, expansion vessel, flow meter, pressure sensor, Y filter, condensate drain fitting, 50 W heating cable, 150 W condensate heating resistance and external probe

Standard safety features:

- high efficiency deaerator to prevent any refrigerant gas leaks in the hydronic circuit
- 2,5 bar safety valve
- hermetically sealed electrical part for explosion-proof safety

SG ready function

Entire range **single-fan** and **Bluefin treatment**

Modbus communication protocol also to work integrated with **home automation systems via BMS port**

HP Keymark Certification

**IMMERGAS PHOTOVOLTAIC.
SMART SOLUTIONS FOR THE HOME**

A photovoltaic system is a source of sustainable energy that is essential for all homes.

Our photovoltaic solutions are designed to communicate with Immergas heat pumps, through the photovoltaic function.

In addition, combined with solar optimizers and storage batteries, they guarantee maximum comfort, a significant reduction in harmful emissions and savings.

This is how they best complete systems in new buildings and renovations.



**SOLAR THERMAL SYSTEMS IN
TECHNOLOGICAL EVOLUTION**

Solar energy represents a valid alternative to fossil fuels; it is renewable, free and clean. Immergas offers solutions that take advantage of this energy, such as the **OMNISTOR and UB PRO SOL storage tanks, specifically designed to be combined with heat pumps** thanks to the larger coils and also designed for use with solar thermal panels, thus contributing to the production of domestic hot water and promoting more sustainable energy consumption.

EXAMPLE OF SOLUTION

Key

1	MAGIS M TOP	11	Relay DHW integration resistance
2	Wired remote panel, NEXIS	12	OMNISTOR storage tank
3	Electrical box, E-BOX TOP	13	Storage tank probe
4	Diverter valve	14	DHW integration resistance
5	50 litres buffer tank	15	Safety inlet group
6	Diverter valve	16	Antifreeze valves
7	Thermostat	17	Gateway Wi-Fi V2
8	Recirculation probe	18	Adjustable by-pass
9	Recirculation pump	19	Shut-off knobs
10	Mixing valve		

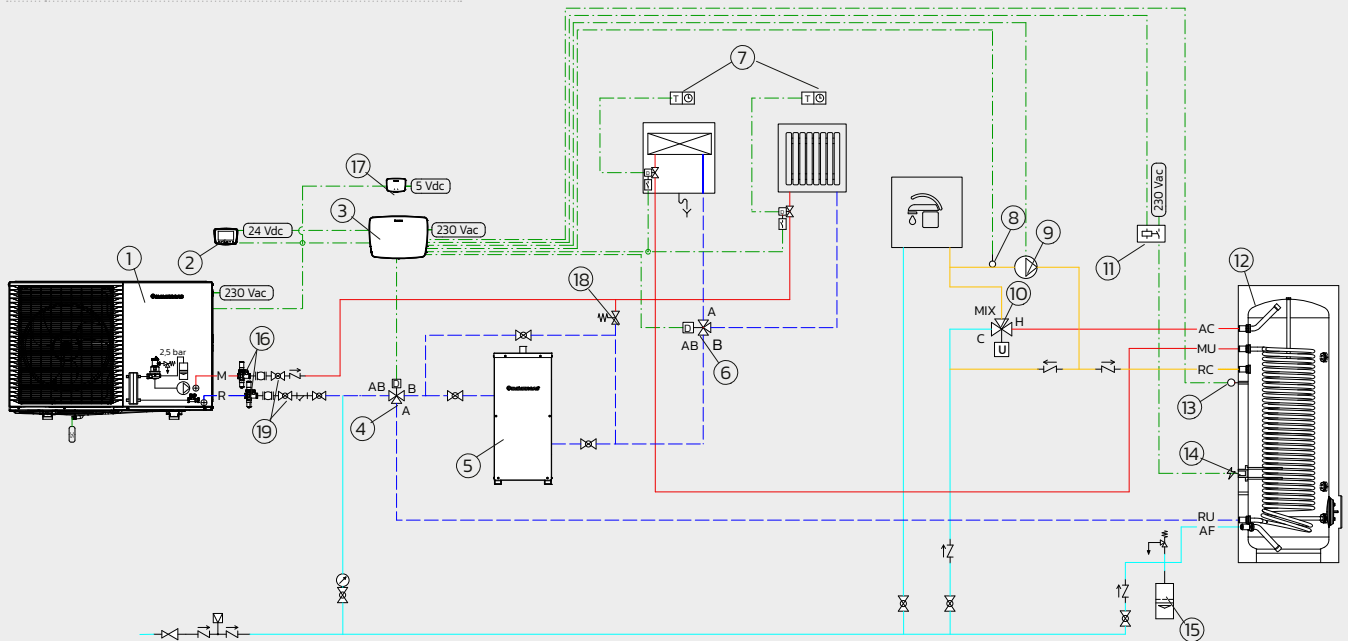

SINGLE-ZONE SYSTEM: HEATING WITH RADIATORS AND COOLING WITH FAN COILS; PRODUCTION OF DOMESTIC HOT WATER WITH STORAGE TANK

Heating/cooling mode

The heat pump (1) starts following a winter request from the chronothermostat (7) or a summer request from the fan coil controlled by the room thermostat (7). Using the NEXIS panel (2) or remotely (APP/web portal) by means of the Gateway Wi-Fi V2 (17), it is possible to switch the operating mode (heating or cooling) and consequently the flow of the summer/winter diverter valve (6).

Domestic hot water mode

When the DHW temperature drops below the set point - checked by the probe located in the boiler (13) - the electronics switches the 3-way valve for domestic hot water/system (4) and turns on the heat pump. The electric resistance of the storage tank (14) is switched on if the DHW start-up time is greater than the set time or outside the heat pump operating range.

By activating the "concomitance" function, in case of a simultaneous request, the electric resistance works on the domestic hot water and the heat pump on the system.

MULTI-ZONE SYSTEM: 2 HEATING/COOLING ZONES WITH RADIANT PANELS AND DEHUMIDIFIERS, 1 HEATING-ONLY ZONE WITH RADIATORS AND A STORAGE TANK FOR THE PRODUCTION OF DOMESTIC HOT WATER

Heating/cooling mode

Following a heating, cooling, or dehumidification request from at least one of the NEXIS panels in the zone, the heat pump (1) is activated in conjunction with the relevant auxiliaries (circulator and/or mixing valve and/or dehumidifier). Using the NEXIS panels or remotely (APP/web portal) by means of the Wi-Fi Gateway V2 (31), it is possible to switch the operating mode (heating or cooling). The system integration resistance (6) is activated if the heating time is longer than the set time or outside the heat pump operating range.

Domestic hot water mode

When the DHW temperature drops below the set point - checked by the probe located in the boiler (28)- the electronics switches the 3-way valve for domestic hot water/system (4) and turns on the heat pump. The electric resistance (29) of the storage tank is switched on if the DHW start-up time is greater than the set time or outside the heat pump operating range. By activating the "concomitance" function, in case of a simultaneous request, the electric resistance works on the domestic hot water and the heat pump on the system.

Legenda

1	MAGIS M TOP	12	System delivery probe	23	Wired remote panel NEXIS zone 3
2	Electrical box, E-BOX TOP	13	Safety thermostat zone 1	24	Circulator pump zone 3
3	Antifreeze valves	14	Circulator pump zone 1	25	Relay DHW integration resistance
4	Diverter valve	15	Mixing valve zone 1	26	Mixing valve
5	Relay C.H. integration resistance	16	Additional zone board kit	27	OMNISTOR storage tank
6	C.H. integration resistance	17	Wired remote panel NEXIS zone 2	28	Storage tank probe
7	75 litres buffer tank	18	Dehumidifier zone 2	29	DHW integration resistance
8	System delivery probe	19	System delivery probe	30	Safety inlet group
9	Additional zone board kit	20	Safety thermostat zone 2	31	Gateway Wi-Fi V2
10	Wired remote panel NEXIS zone 1	21	Circulator pump zone 2	32	Shut-off knobs
11	Dehumidifier zone 1	22	Mixing valve zone 2		

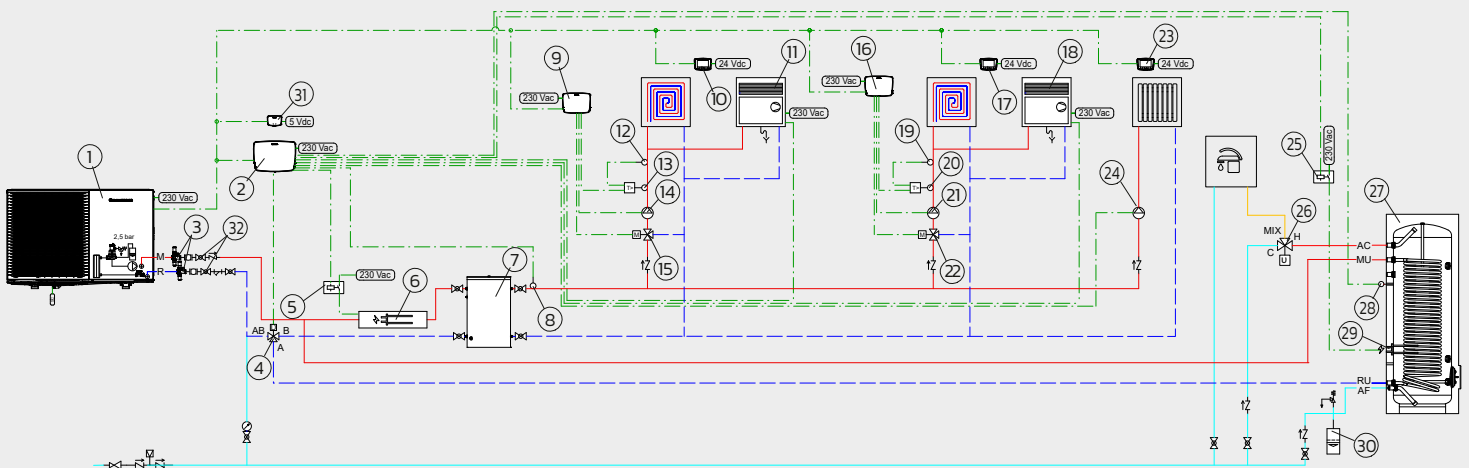

TECHNICAL DATA

Technical characteristics	Unit of measurement	MAGIS M5 TOP	MAGIS M8 TOP	MAGIS M12 TOP	MAGIS M16 TOP	MAGIS M12 T TOP	MAGIS M16 T TOP
Code		3.035574	3.035575	3.035576	3.035577	3.035578	3.035579
Energy class in heating at 55 °C		A++	A++	A++	A++	A++	A++
Energy class in heating at 35 °C		A+++	A+++	A+++	A+++	A+++	A+++
Refrigerant charge (R290)	g	630	870	1250	1250	1250	1250
Power in CH with water set at 35 °C	kW	5	8	12	16	12	16
Power in CH with water set at 45 °C	kW	5	8	12	16	12	16
Power in CH with water set at 55 °C	kW	5	8	12	16	12	16
Flow temperature range (C.H.)*	°C	15/75	15/75	15/75	15/75	15/75	15/75
COP with water set at 35 °C		5,10	4,91	4,80	4,51	4,80	4,51
COP with water set at 45 °C		3,79	3,70	3,70	3,50	3,70	3,50
COP with water set at 55 °C		3,11	3,00	3,00	2,90	3,00	2,90
Power in cooling with water set at 18 °C	kW	5	8	12	14	12	14
Power in cooling with water set at 7 °C	kW	3,9	5,7	9	10,4	9	10,4
Flow temperature range (cooling)	°C	5/25	5/25	5/25	5/25	5/25	5/25
EER with water set at 18 °C		3,91	3,90	4,00	3,80	4,00	3,80
EER with water set at 7 °C		3,05	3,00	2,90	2,90	2,90	2,90
Flow temperature range (DHW)*	°C	25/70	25/70	25/70	25/70	25/70	25/70
Max. operating pressure hydraulic system (vessel preload pressure)	bar	2,5 (1)	2,5 (1)	2,5 (1)	2,5 (1)	2,5 (1)	2,5 (1)
Heat pump power absorbed**	W	980	1630	2500	3550	2500	3550
Power supply	V – Hz	230–50	230–50	230–50	230–50	400–50	400–50
Net heat pump weight (gross)	kg	113 (124,7)	125 (136,7)	154 (166,7)	154 (166,7)	154 (166,7)	154 (166,7)
Expansion vessel capacity (C.H.)	l	10	10	10	10	10	10
Maximum absorbed current	A	16,1	26	32	32	16,1	16,1
Electrical insulation rating	IP	X4D	X4D	X4D	X4D	X4D	X4D

** The maximum values can be reached with the contribution of electric resistances. In order to know the correlation between delivery temperature and external temperature consult the technical data sheet of the product.

*** T. system water (D/R) – air (bs/bu) 35/30 °C – 7/6 °C.

Referred to the following conditions:

Environment	Heating (°C)	Cooling (°C)
T system water (D/R) – air (bs/bu)	30/35 – 7/6	23/18 – 35 (bs)
T system water (D/R) – air (bs/bu)	40/45 – 7/6	12/7 – 35 (bs)
T system water (D/R) – air (bs/bu)	55/47 – 7/6	

For more information consult the technical sheet or the website immergas.com



MAGIS M5/8 TOP

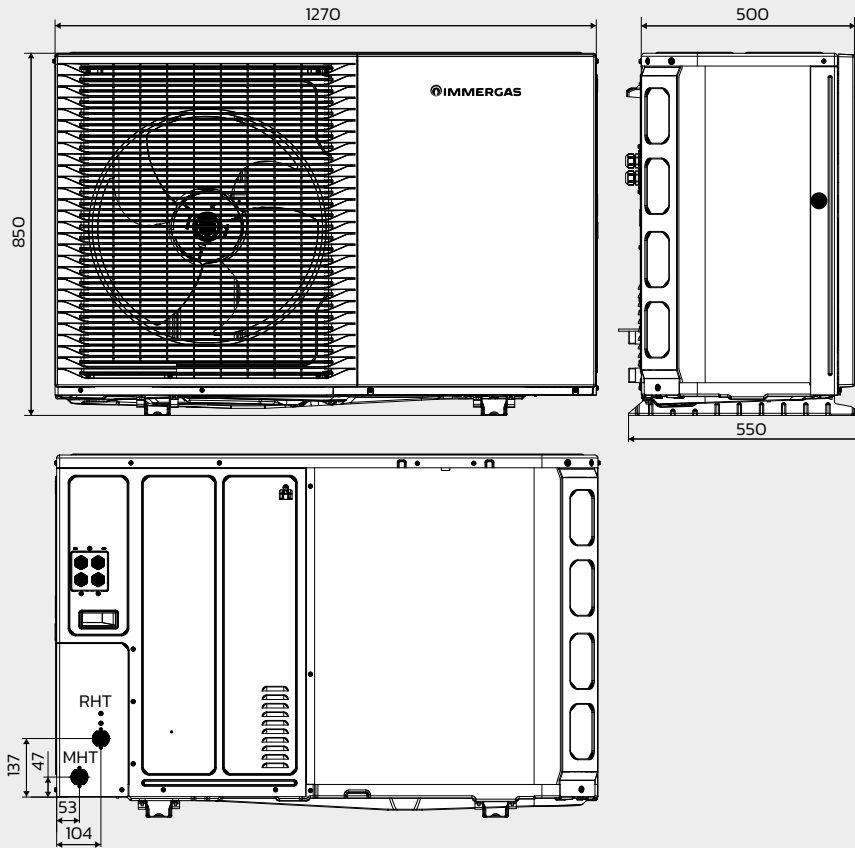

Key

- R System return
- M System delivery

Connections
MAGIS M 5/8 TOP

RHT	MHT
1" M	1" M

MAGIS M12/16 TOP (single and three-phase)

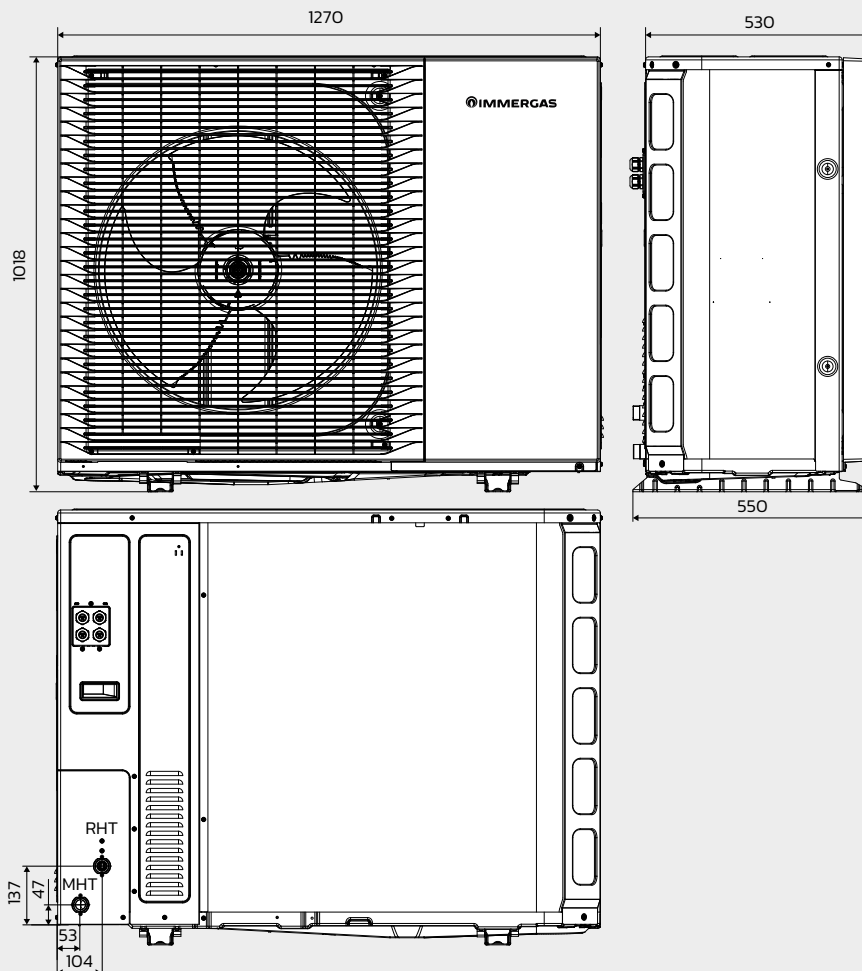

Key

- R System return
- M System delivery

Connections
MAGIS M 12/16 TOP
(single and three-phase)

RHT	MHT
1" M	1" M



MINIMUM DISTANCES

For proper machine operation and maintenance.

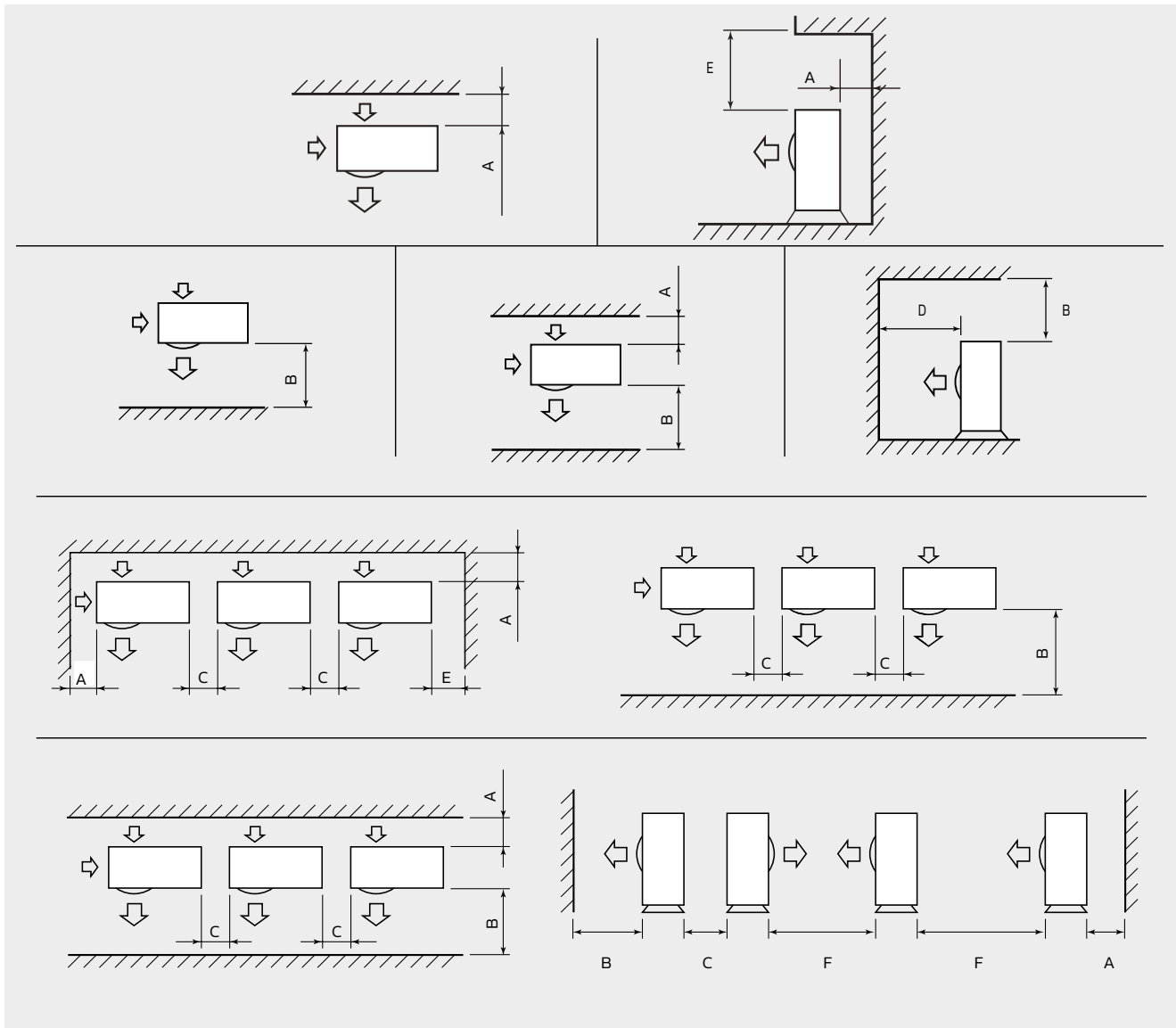

Model	A	B	C	D	E	F
MAGIS M TOP	300	1500	1000	2300	600	3000

Warning: Be sure to observe the "Safety Zone" around the installation area.
For relevant instructions, refer to the Instructions and recommendations manual of the appliance.

Head-flow rate curve for MAGIS M5/8 TOP

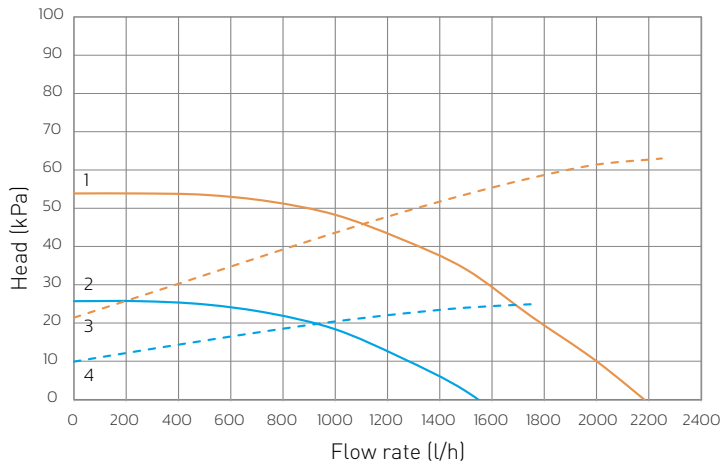

Key

- 1 = Head available to the system max speed
- 2 = Head available to the system min speed
- 3 = Absorbed power by the circulator max speed
- 4 = Absorbed power by the circulator min speed

Head-flow rate curve for MAGIS M12/16 TOP (single and three-phase)

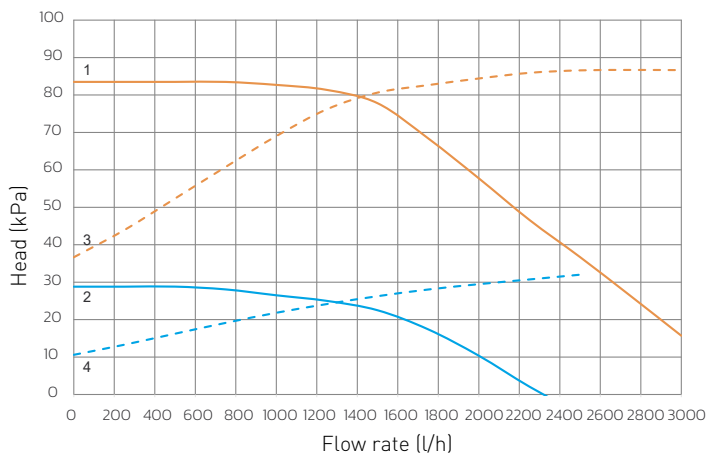

Key

- 1 = Head available to the system max speed
- 2 = Head available to the system min speed
- 3 = Absorbed power by the circulator max speed
- 4 = Absorbed power by the circulator min speed

Thermoregulation

Combining MAGIS M TOP with a thermoregulation device is an excellent investment because it improves the seasonal energy efficiency of the system.

NEXIS - Wired remote additional panel

Type		Code
User interface for managing the operation of MAGIS M TOP. It is also chronothermostat and a temperature/humidity sensor. NEW	 <p>Dimensions (H x W x D) mm 103 x 147,4 x 20,5</p>	3.035812
User interface for managing the operation of MAGIS M TOP. It is also chronothermostat and a temperature/humidity sensor. NEW	 <p>Dimensions (H x W x D) mm 103 x 147,4 x 20,5</p>	3.035829

Additional zone board kit

It allows you to manage auxiliaries such as: circulation pump, mixing valve and delivery probe. NEW	 <p>Dimensions (H x W x D) mm 199 x 242 x 49</p>	3.035840
--	--	----------

Gateway Wi-Fi V2

To remotely manage MAGIS M TOP using both the dedicated app and the portal. Alexa and Google Home compatible. NEW	 <p>Dimensions (H x W x D) mm 87 x 124 x 26</p>	3.035537
--	---	----------

Dehumidifier relay board kit

To manage the dehumidifier (and any related valve) in neutral and/or cooled air. NEW		3.036231
---	--	----------

Temperature/humidity active sensor Modbus kit

To control temperature and humidity	 <p>Dimensions (H x W x D) mm 80 x 127 x 30</p>	3.030992
-------------------------------------	---	----------

CRONO 7

ON/OFF room thermostat	 <p>Dimensions (H x W x D) mm 103 x 142 x 31</p>	3.021622
------------------------	--	----------

WIRELESS version available - code 3.021624.

Room hygrostat

To control humidity	 <p>Dimensions (H x W x D) mm 70 x 115 x 40</p>	3.023302
---------------------	--	----------



External probe

Type		Code
To be used when external probe as standard in outdoor unit is not correctly exposed.		3.015266
NTC contact probe kit		
To control DHW storage tank temperature and delivery system/and or zones.		3.019375
NTC cuff probe kit		
To control temperature delivery system/and or zones. It includes a band to fix probe.		3.030913
System controller kit		
It is possible to select and activate the most convenient heat source based on the set environmental and economic parameters. Backlit display. Power supply must be via 48 VDC or 24 VAC – 50 Hz transformer (not included).	 Dimensions (H x W x D) mm 110 x 105 x 60	3.021522
Remote control panel		
Modulating chronothermostat, remote control with temperature/humidity sensor. Only in combination with system controller kit (code 3.021522).	 Dimensions (H x W x D) mm 100 x 129 x 37	3.030863
System controller expansion kit		
Only in combination with system controller kit (code 3.021522). It allows you to manage auxiliaries such as: circulation pump, mixing valve, dehumidifier, recirculation pump, and 3-way diverter valves for heating/cooling. This accessory is already included as standard in the zones kits codes 3.021527 and 3.021528.	 Dimensions (H x W x D) mm 110 x 70 x 60	3.021547
Temperature/humidity active sensor Modbus kit		
To control temperature and humidity. Only in combination with system controller kit (code 3.021522).	 Dimensions (H x W x D) mm 80 x 127 x 30	3.021524



EMR 12 VDC relay kit

Type	Code
<p>Only in combination with system controller kit (code 3.021522). To activate DHW resistance, to manage ON-OFF contact of the boiler or to activate dehumidifier.</p>	3.023945

SSR 6 VDC relay kit

<p>Only in combination with system controller kit (code 3.021522). To activate system electric resistance.</p>	3.023946
---	----------

Solar collector probe

<p>Only in combination with system controller kit (code 3.021522). To manage solar thermal system.</p>	3.019374
---	----------



DOMINUS V2 interface kit

<p>Wi-fi interface kit to remote control by app. Only in combination with system controller (code 3.021522).</p>	 <p>Dimensions (H x W x D) mm 113,5 x 123,5 x 33,5</p>	3.034903
---	--	----------

Options Kits

Buffer tanks

To facilitate proper execution of the heat pump defrost cycles and to avoid the intermittent operation of the appliance, a minimum water content in the system is required, which must be 30 litres for MAGIS M5/8 TOP and 50 litres for MAGIS M12/16 TOP (single or three-phase). Furthermore, it is advisable to check that the dehumidifier line has a minimum of 3 l/kW of the machine (dehumidifier hydraulic circuit connection).

Type	Code	
<p>Vertical 50 litres buffer tank (RAL 7030) NEW</p>	 <p>Dimensions (H x W x D) mm 820 x 360 x 360</p>	3.036742
<p>Vertical 50 litres buffer tank</p>	 <p>Dimensions (H x W X D) mm 820 x 360 x 360</p>	3.027539

Buffer tank

Type		Code
75-litres vertical buffer tank kit With 4 connections, it also works as a hydraulic separator. It can only be installed inside the building.		3.027288
Bracket kit for wall mounting 75 litres buffer tank.		3.027290

3 way diverter valve kit

To exclude the inertial buffer tank (in summer mode) or for summer/winter switching.		3.020632
--	--	----------

System electric heater kit

Adjustable to 2, 4 or 6 kW (to be installed inside the home).		3.021525
---	--	----------

Dehumidifier kit

Dehumidifier kit* (only for recessed installation with codes 3.022146 and 3.022147).		3.021529
Dehumidifier back frame kit*		3.022146
Dehumidifier front grille kit*		3.022147







* Useful for radiant systems that work also in cooling.

Mechanical ventilation

ZENITAIR-MONO Mechanical bidirectional ventilation unit.		3.030601
External cover kit with acoustical insulation for ZENITAIR-MONO. Anti-insect net and anti-wind in pre-painted steel.		3.030636



Kit zones

Type		Code
<p>For MAGIS M5/8 TOP 2 heating/cooling zones kit (one direct and one mixed).</p>	 <p>Dimensions (H x W x D) mm 700 x 450 x 190</p>	<p>3.026301</p>
<p>For MAGIS M12/16 TOP (single and three-phase) 2 heating/cooling zones kit (one direct and one mixed).</p>	 <p>Dimensions (H x W x D) mm 700 x 450 x 190</p>	<p>3.031695</p>
<p>For MAGIS M5/8 TOP 2 direct zones, heating only</p>	 <p>Dimensions (H x W x D) mm 700 x 450 x 190</p>	<p>3.032264</p>
<p>For MAGIS M5/8 TOP 2 zones kit, one direct and one mixed, heating only.</p>	 <p>Dimensions (H x W x D) mm 700 x 450 x 190</p>	<p>3.032265</p>
<p>For MAGIS M12/16 TOP (single and three-phase) 2 zones kit, one direct and one mixed, heating only.</p>	 <p>Dimensions (H x W x D) mm 700 x 450 x 190</p>	<p>3.035333</p>
<p>For MAGIS M12/16 TOP (single and three-phase) 2 direct zones, heating only.</p>	 <p>Dimensions (H x W x D) mm 700 x 450 x 190</p>	<p>3.035334</p>

Kit zones

Type		Code
<p>Only in combination with system controller (code 3.021522). For MAGIS M5/8 TOP 3 heating/cooling zones kit (one direct and two mixed)</p>	 <p>Dimensions (H x W x D) mm 700 x 450 x 190</p>	3.021527
<p>Only in combination with system controller (code 3.021522). For MAGIS M5/8 TOP 2 heating/cooling zones kit (two mixed).</p>		3.021528
<p>Shut off knobs for zones kit</p>		3.014948

Shut off knobs kit

<p>With G 1" steel flexible pipes</p>		3.025954
---------------------------------------	--	----------

Antivibration support kit



<p>The kit includes: - 2 anti-vibration supports - 100 mm high - 4 M8 nuts, washers, and bolts</p> <p>NEW</p>		3.035580
--	---	----------

System expansion vessel

<p>12 litres</p>		3.011679
------------------	--	----------



Storage tanks for domestic hot water



Type		Code
<p>OMNISTOR 300 Stainless steel storage tanks for domestic hot water production. Equipped with oversized single coil.</p>	 <p>Dimensions (H x Ø)</p> <p>OMNISTOR 300 mm 1715 x 620</p> <p>OMNISTOR 500 mm 1735 x 810</p>	3.027910
<p>OMNISTOR 500 Stainless steel storage tanks for domestic hot water production. Equipped with oversized single coil.</p>		3.027911
<p>UB PRO SOL 800 NEW Vitrified steel storage tanks for domestic hot water production. Equipped with two coils one of which oversized for the connection to heat pump.</p>	 <p>Dimensions (H x Ø)</p> <p>UB PRO SOL 800 mm 1985 x 990</p> <p>UB PRO SOL 1000 mm 2185 x 990</p>	3.035550
<p>UB PRO SOL 1000 NEW Vitrified steel storage tanks for domestic hot water production. Equipped with two coils one of which oversized for the connection to heat pump.</p>		3.035551

DHW electric resistance kit

<p>2 kW For OMNISTOR and UB PRO SOL</p>	3.020861
<p>5 kW For UB PRO SOL</p>	3.020862

For other option kits dedicated to the storage tank units, see the related section on immergas.com

Fancoil units

Tipologia		Code
HYDRO FS 200 Floor standing hydronic fancoil		3.028500
HYDRO FS 400 Floor standing hydronic fancoil		3.028501
HYDRO FS 600 Floor standing hydronic fancoil		3.028502
HYDRO FS 800 Floor standing hydronic fancoil		3.028503
HYDRO FS 1000 Floor standing hydronic fancoil		3.028505
HYDRO IN 200 Recessed hydronic fancoil		3.029841
HYDRO IN 400 Recessed hydronic fancoil		3.029842
HYDRO IN 600 Recessed hydronic fancoil		3.029843
HYDRO IN 800 Recessed hydronic fancoil		3.029844
HYDRO IN 1000 Recessed hydronic fancoil		3.029845
Smart touch wall controller with temperature probe (black casing)*		3.030877
Smart touch wall controller with temperature probe (white casing)*		3.030878
On board electronic control with PID full modulating fan*		3.030876
Sheet metal feet kitfor HYDRO FS		3.028506
Modulating thermoregulation kit for HYDRO FS*		3.028509
4 speed thermoregulation kit for HYDRO FS*		3.028510
Universal control board for commercial thermoregulation*		3.028511
Electronic control board with 0-10 V connection*		3.028512
Connection cable to shift water connections from left to right		3.029834
2-way group valve kit		3.028507
3-way group valve kit		3.028508
HYDRO 3 V2 Wall-hung hydronic fancoil with remote control and three-way valve with end switch for ON-OFF contacts.		3.033625
HYDRO 4 V2 Wall-hung hydronic fancoil with remote control and three-way valve with end switch for ON-OFF contacts.		3.033626
Connection kit for HYDRO 3/4 V2 left exit		3.029520

* Note: one of these kits is mandatory for the fancoil functioning.

For the built-in installation of the HYDRO IN, see the relevant kits on Immergas website.





Immergas S.p.a.

42041 Brescello (RE) - Italy

T. 0522.689011



[immergas.com](https://www.immergas.com)

