



USER'S MANUAL

**IE**

**Instructions  
and warnings**

 **IMMERGAS**

**Code 3.030863**

Zone Remote  
Panel



*Dear Customer,*

*Congratulations for having chosen a top-quality **Immergas product**, able to assure well-being and safety for a long period of time.*

*As an **Immergas customer** you can also count on a qualified after-sales service, prepared and updated to guarantee constant efficiency of your "Remote Control".*

*We would like to provide you with some important indications, your observance of which will ensure your satisfaction with the **Immergas product**:*

- *Read the following pages carefully: you will find useful suggestions regarding the correct use of the device.*
- *For assistance and scheduled maintenance, contact "**Immergas Authorised After-Sales centres**": they have original spare parts and are specifically trained.*

## INDEX

Page

How to use the instruction book.....	25
Foreword.....	25
General warnings .....	25
Cleaning the case.....	26
<b>1. Installation</b> .....	<b>27</b>
1.1 Zone Remote Panel main dimensions.....	27
1.2 Zone Remote Panel installation operations.....	28
<b>2. Use of the Zone Remote Panel</b> .....	<b>31</b>
<b>3. Operating mode selection</b> .....	<b>32</b>
<b>4. Main page setting</b> .....	<b>33</b>
<b>5. Summer mode functions</b> .....	<b>33</b>
<b>6. Winter mode functions</b> .....	<b>34</b>
6.1 Automatic functioning.....	35
6.2 Temporary manual functioning (👉).....	35
<b>7. Summer mode with cooling functions</b> .....	<b>36</b>
<b>8. Operation with external probe</b> .....	<b>36</b>
<b>9. Time and program menu</b> .....	<b>37</b>
<b>10. Settings Menu</b> .....	<b>37</b>
<b>11. Technical characteristics</b> .....	<b>45</b>
11.1 Product Sheet.....	45

## HOW TO USE THE INSTRUCTION BOOK

The instruction book has been divided into 3 main parts:

**in the first**, for the installer, the assembly and connection phases of the Zone Remote Panel with the boiler are described;

**in the second**, all operating program customisation phases are described;

**in the third** and last part, all operations for displaying and keeping system operation under control are described.

## FOREWORD.

The “**Zone Remote Panel**” is a device designed to guarantee ideal temperature conditions at any time of the day and night for each individual day of the week.

Its installation takes a few minutes: it is connected to an appliance via 4 cables, through which, it receives and sends the adjustment and control commands and receives the power supply. On completion of installation it is ready to function thanks to the pre-set program inside. The customer can modify the basic program according to requirements. Programming the Zone Remote Panel is extremely easy and a wide display allows constant control of all values set.

## GENERAL WARNINGS

This manual was intended for: **the Installer** and **the User**.

- Carefully read the warnings contained in this document as they are required to indicate the use of the Zone Remote Panel envisioned by the design hypothesis, the technical features, the installation, assembly, programming, adjustment and use instructions.
- The system must be compliant with applicable IEC Standards.
- The instruction manual must be considered a part of the Zone Remote Panel and must be “**kept for future reference**”.
- After having removed the packaging, check the integrity of the Zone Remote Panel. If in doubt, do not use it and contact the **Dealer or Manufacturer**.
- The Zone Remote Panel is destined only for the use for which it has been expressly designed. Any other use must be considered improper and therefore dangerous.

- Our products are manufactured in compliance with the Safety Standards in force. It is, therefore, recommended to use all devices and attention in such a way that injury/damage is not caused to persons or objects.
- Do not remove parts of the Zone Remote Panel when it is functioning.
- Do not use the Zone Remote Panel if exposed to heat sources or under the scorching sun.
- The manufacturer will not be held responsible in the following cases:
  - a) Incorrect installation.
  - b) Unauthorised changes or tampering.
  - c) Total or partial failure to comply with instructions.
  - d) Exceptional events etc.

## **CLEANING THE CASE**

To clean the case of the Zone Remote Panel use damp cloths. Never use abrasive or powder detergents.

### **WARNING**

Immergas reserves the right to make improvements and changes to details and accessories, excepting the essential features of the model described and illustrated herein.

# 1. INSTALLATION

## 1.1 Zone Remote Panel main dimensions.

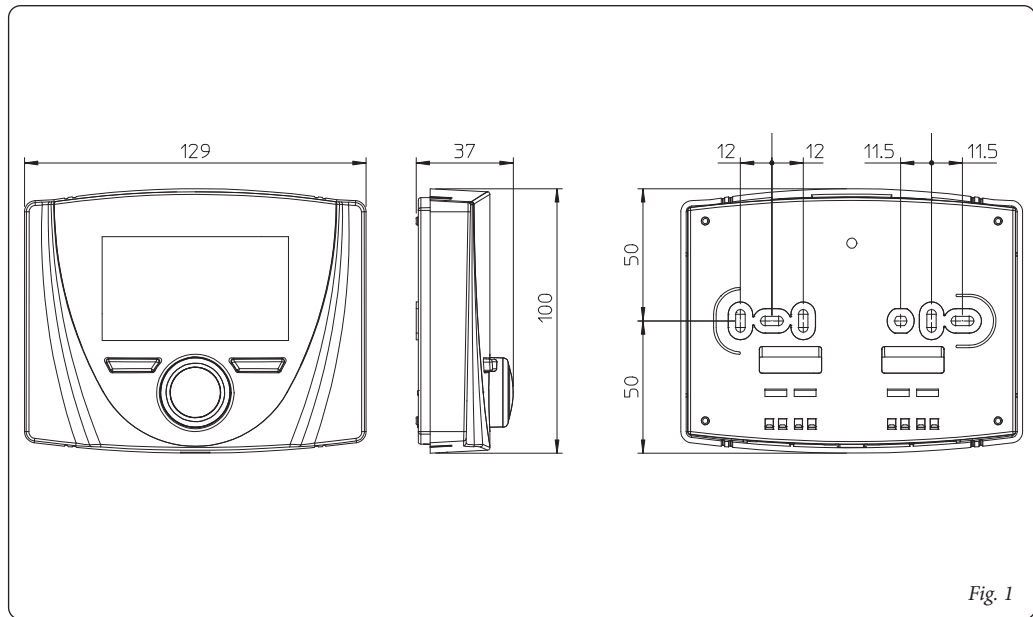

Fig. 1

## 1.2 Zone Remote Panel installation operations.

- 1) Separate the fixing template from the body of the Zone Remote Panel using a screwdriver as a lever in the relative recess (*Fig. 2*). Install the Zone Remote Panel away from heat sources and in a suitable position to detect the room temperature correctly.
- 2) Install the Zone Remote Panel using the openings on its rear part directly onto the wall or on a recess box using the relative supplied screws.
- 3) Connect the Zone Remote Panel to the electronic management clamps, as indicated in the wiring diagram.

The connection is made using wires with a minimum section of  $0.50 \text{ mm}^2$  and maximum section of  $1.5 \text{ mm}^2$  and with a maximum length of 50 metres.

**N.B:** for correct installation, prepare a dedicated line to connect the Zone Remote Panel according to the Standards in force regarding electrical systems. If this is not possible, interference due to other electric cables could cause malfunctioning of the Zone Remote Panel itself.

- 4) Fix the body of the Zone Remote Panel to the mount template, engaging it with pressure.
- 5) After the device has been powered, wait about 30 seconds before regulation so that communication between Zone Remote Panel and the device has established.

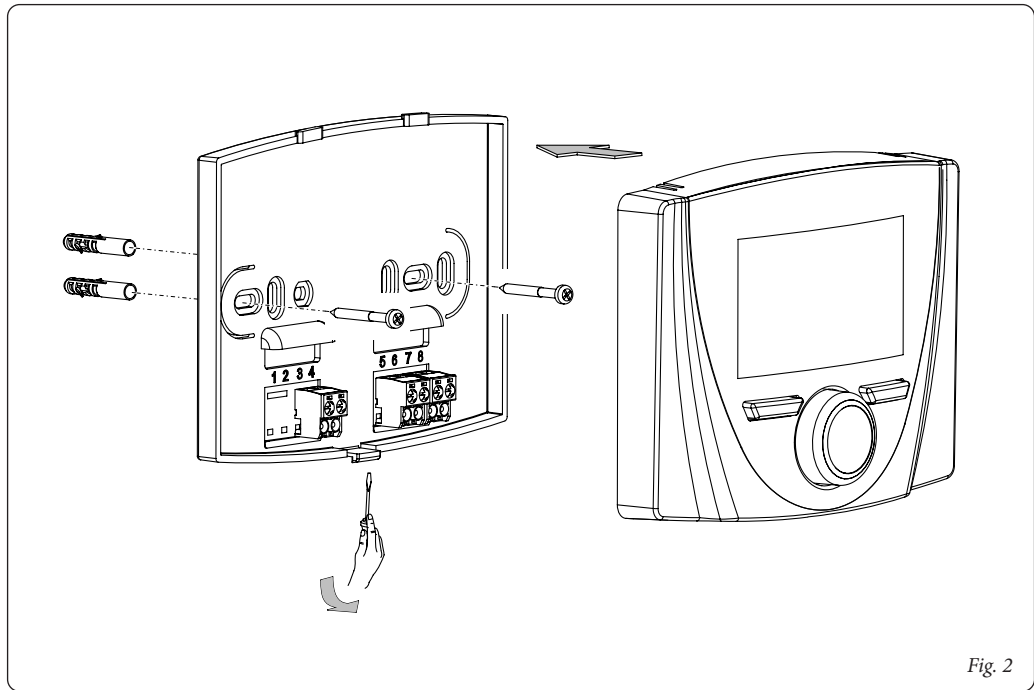

Fig. 2

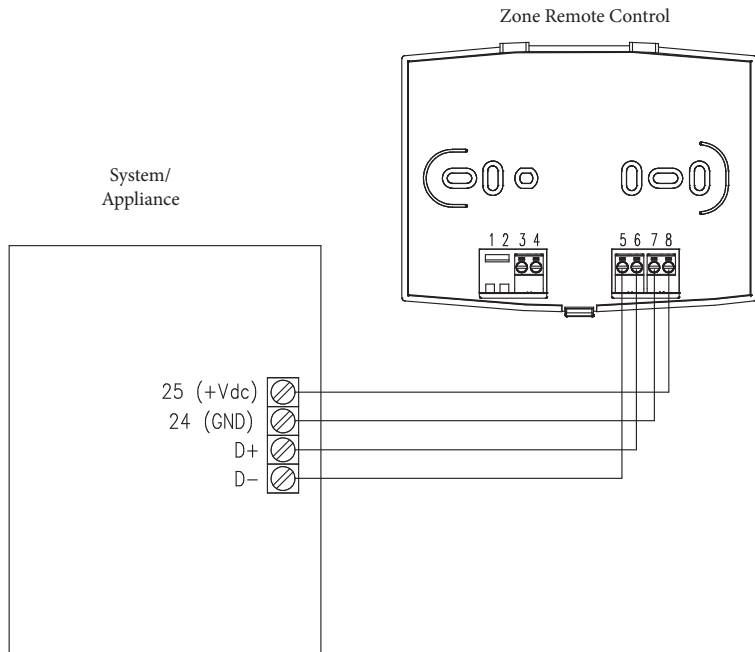
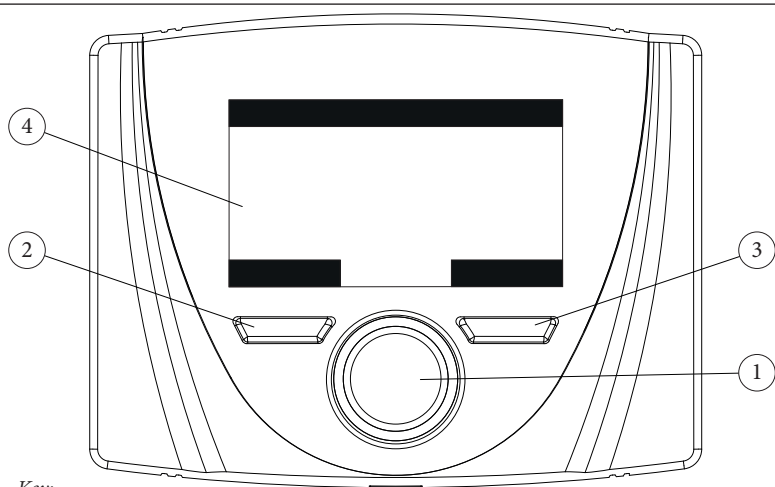

Fig. 3



## 2. USE OF THE ZONE REMOTE PANEL



Key:

- 1 - Main parameters switch with button to confirm and save data
- 2 - Left context button
- 3 - Right context button
- 4 - Display

Fig. 4

### 3. OPERATING MODE SELECTION.

According to the functioning mode selected, the Zone Remote Panel performs the requests of the user, displaying the results on the display. Press the “Mode” button to select the following functions: Stand-by, Summer, Summer with Cooling, Winter (Fig. 5). If multiple Zone Remote Panels are present, the operating mode is continuously updated between the various devices.

**Stand-by / antifreeze mode** () . In this mode, the appliance can only function in the event of antifreeze request, where this option is available.









**Summer mode** () . In this mode the appliance is enabled for producing domestic hot water excluding heating or cooling the room.



**Summer with Cooling mode** () . In Summer with Cooling mode, the appliance is enabled for the production of domestic hot water, for the production of room cooling and for room dehumidification.

In “Cooling” mode, the Zone Remote Panel can operate in automatic or temporary manual mode.

**Winter mode** () . In Winter mode the appliance is enabled for producing domestic hot water and for central heating the room. In Winter mode, the Zone Remote Panel can operate in automatic or temporary manual mode.

Depending on the system mode, the main screen displays various information regarding the system, amongst which:

Status	Description
 nn	Room humidity value
 nn	External temperature value (external probe enabled)
	Production of Domestic Hot Water in progress
	Request for room central heating or cooling in progress
	Dehumidify and cool room in progress
	Dehumidify room in progress
	Comfort Temperature operation
	Economy Temperature operation

	Operation in manual mode
	External probe enabled
	Anomaly present

#### 4. MAIN PAGE SETTING.

The area to which the information refers is shown at the centre of the display. It is possible to display the information on the Zone and on the domestic hot water part.

Simply press the main switch to cyclically go from Zone to DHW (Domestic hot water).

The lower part of the display shows the parameter that can be changed (it varies according to the appliance configuration), it is possible to change the value by turning the main switch and pressing it to confirm the parameter change.

The values that can be found according to the configuration, are:

- Set room: defines the room zone temperature.
- Set flow: defines the system's flow temperature to the zone.

- Flow offset: changes the operation curve of the external probe.
- DHW (Domestic hot water) set: this defines the DHW temperature.

#### 5. SUMMER MODE FUNCTIONS.



With the Zone Remote Panel in Summer mode () , only the production of DHW is enabled.

The DHW setpoint can be set from the dedicated page.

If you want to regulate the request for domestic hot water in distinct time bands (Comfort and Economy), it can be set in the Sanitary Setpoint Menu, if the device to which the Zone Remote Panel is connected includes this logic. The time slots used are the same as those used for setting the area's heating / cooling request.

## 6. WINTER MODE FUNCTIONS.

With the Zone Remote Panel in Winter mode () , the production of DHW and room central heating are enabled. Two main functioning modes can be selected for room central heating: automatic or temporary manual.

- **Automatic** (): the room temperature is regulated on two levels Comfort (sun) and Economy (moon) during the day via a program set by the user.
- **Temporary manual** (): the room temperature is modified momentarily with respect to automatic functioning until the successive passage between Comfort and Economy mode of the automatic program set.







Status	Description
	Stand-by
	Summer
	Summer with Cooling
	Winter

Fig. 5



### 6.1 Automatic functioning.

The Zone Remote Panel allows automatic functioning, in which a program manages the room temperature during the hours of the day.

The desired room temperature can be adjusted onto two independent levels: Comfort () and Economy () in the Zone Setpoint menu, whose distribution throughout the day or the week is managed by hourly programming. Press the button until the icon switches-on on the display. The Zone Remote Panel is factory set with a standard program shown below. If this should not satisfy requirements, it is possible to modify it as described in the chapter relative to programming.

The system is designed to function on Comfort and Economy temperature levels depending on the hour program set. Therefore also during operation on Economy level, if the room temperature measured is below that set, the appliance may function.

### 6.2 Temporary manual functioning (.

If the room temperature is changed in automatic operation ( - ) , Temporary manual operation is activated. In this mode, the room temperature will be regulated to the value set until the next switch-on or switch-off phase of the automatic program set.

The forced automatic function can be interrupted by simply changing the operation mode.

## 7. SUMMER MODE WITH COOLING FUNCTIONS

With the Zone Remote Panel in Summer mode with Cooling () , the production of DHW, room central cooling and room dehumidifier are enabled. Two main functioning modes can be selected: automatic or temporary manual. These operating modes are similar to those found in the WINTER mode.

The room dehumidification function is activated automatically according to the humidity setpoint set on the Zone Remote Panel (see Zone Setpoint Menu) and the relevant room humidity value measured by the device.

The room dehumidification function is a manual function, i.e. it does not depend on the set time program.

## 8. OPERATION WITH EXTERNAL PROBE.

When the external probe is enabled in the appliance, the symbol is shown on the Zone Remote Panel display (). From this moment, the system's flow temperature for room central heating is calculated depending on the external temperature measured. It is possible to change the operation curve by using the main switch and changing the external probe offset (*Ref. 1 Fig. 4*).

## 9. TIME AND PROGRAM MENU.

### • Time slots.

The Zone Remote Panel allows you to set 4 calendars with up to 4 slots. During the set time slots, the system will be in Comfort mode.

After setting these 4 calendars it is possible to associate them to the various days of the week.

Press the “Menu” button. Select by pressing the main selector (*Ref. 1 Fig. 4*) the item “Time and program”, then “Time slots”.

Once you have accessed the menu, adjust the various items highlighted by turning the main switch. Set the value and save it by pressing the main switch. Each time it is saved, it moves to the next item.

After programming, press “Conferma” (Confirm).

### • Time programme.

Time slots are assigned to Zones in these menus (Calendars from 1 to 4) to the associated Zone, both sanitary and heating. You can assign the calendar to a single day or to a group of days. (single day, Monday - Friday, Saturday - Sunday, Monday - Saturday, Monday - Sunday).

Therefore each day may be personalised with 4 different operating programs.

For convenient selection, the bottom part displays the graphics of the relevant calendar being selected.

### • Holiday programme.

In case of need it is possible to suspend the operation of the system for a certain period, if the device to which it is connected has this function.

In the menu you can enter the start and end dates of the holiday.

## 10 SETTINGS MENU.

By pressing the “Menu” button you can access a list of menu items to customize the Zone Remote Panel.

To browse the menus, which can be accessed by pressing the relative “RH” or “LH” context buttons, scroll through the sub-menus displayed by turning the main switch.

Press the said selector to select the one highlighted.

By pressing repeatedly, you can scroll down the menu levels and go back to a previous level by pressing the “Indietro” (Back) context button. To exit the menu completely, press the “Esci” (Exit) button, which will take you back to the initial page of normal operation.

To confirm the parameter change, press the main switch.

**Note: The default values depend on the device connected to the Zone Remote Panel, except those indicated below.**

**Note: Parameters not managed by the device connected to the Zone Remote Panel are displayed with the symbol “--”.**

Hereunder is a list of available menus.

MAIN MENU	
Menu item	Description
Setpoint Zone	Defines the operating parameters to manage the zone
Setpoint DHW	Defines operating parameters for domestic hot water management
Time and program	Defines the operating time slots
Information	Display system operating data
User	Defines user-modifiable system parameters
Service	Password protected menu dedicated to a qualified technician
Language	Defines the Zone Remote Panel operation language

Setpoint Zone Menu			
Menu item	Description	Range	Customised value
Set comfort heat.	Room temperature heating zone in Comfort mode	15 ÷ 35 °C	
Set economy heat.	Room temperature heating zone in Economy mode	5 ÷ 25 °C	
Set comfort cool.	Room temperature cooling zone in Comfort mode	15 ÷ 35 °C	
Set economy cool.	Room temperature cooling zone in Economy mode	15 ÷ 35 °C	
Set umidity cool.	Humidity value set for zone in cooling mode	30 ÷ 70 %	



## Setpoint Zone Menu

Menu item	Description	Range	Customised value
Set flow	Flow setpoint of the zone	5 ÷ 80 °C	
Offset	Flow offset of the zone	-15 ÷ 15 °C	

## Setpoint DHW Menu

Menu item	Description	Range	Customised value
Set Comfort	Setpoint DHW in Comfort mode	20 ÷ 65 °C	
Set Economy	Setpoint DHW in Economy mode	10 ÷ 65 °C	
Set Manual	Setpoint DHW Manual	10 ÷ 65 °C	
DHW Temperature	Temperature read by DHW probe	10 ÷ 65 °C	
Time program Enable	Enabling DHW time slots	MAN / AUTO	
Antilegio function	Enabling Antilegio function	OFF / 24h / 7gg	

### Time and program menu

Menu item	Description	Range	Customised value
Time slots	Defines the time range for operation in Comfort and Economy mode		
Program Zone	Time zone scheduling	Mon - Sun Cal1 - Cal4	
Program DHW	DHW time scheduling	Mon - Sun Cal1 - Cal4	
Program Holiday	Holiday scheduling		

### Information Menu

Menu item	Description
External temperature	External temper. detected by the external probe
Set system temp. calc.	Flow temperature requested by the generators
Room Temp.	Temperature read by Zone Remote Panel room probe
Room Humidity	Humidity read by Zone Remote Panel humidity sensor
Flow temperature	Temperature read by the flow sensor of the main generator
Return temperature	Temperature read by the return sensor of the main generator
Flow temperature 2	Temperature read by the flow sensor of the backup generator

### Information Menu

Menu item	Description
Return temperature 2	Temperature read by the return sensor of the backup generator
DHW Setpoint	DHW Setpoint
DHW Temp.	Temperature read by DHW probe
Board firmware ver.	System firmware revision
Display firmware ver.	Zone Remote Panel firmware revision

### User Menu

Menu item	Description	Range	Customised value
HP Disable	It allows to disable the heat pump according to the set time slot	Yes / No	
HP Disable Start	Allows to set when disabling starts	0 - 23 h	
HP Disable End	Allows to set when disabling ends	0 - 23 h	
Dehumidification Disable	Disabling of request to the dehumidifier, according to the daily time slot	Yes / No	
Dehum. Disable Start	Time of dehumidification request disabling phase start	0 - 23 h	
Dehum. Disable End	Time of dehumidification request disabling phase end	0 - 23 h	
CH min. set	Minimum flow temperature for heating	20 ÷ 85 °C	
Max cooling setpoint	Maximum flow temperature in cooling	5 ÷ 25 °C	

Service Menu			
Menu item	Description	Range	Customised value
<b>Password protected menu dedicated to a qualified technician</b>			

Language Menu				
Menu item	Description	Range	Default	Customised value
Language	Defines the Zone Remote Panel operation language	ITA - ENG - POL	ITA	

The Zone Remote Panel is set up for possible programming of several operation parameters. By modifying these parameters as described below, the system can be adapted according to specific needs.

Access the “Assistenza” (Service) menu by pressing the right “Menu” button and turning the main switch until selecting the desired menu. Press the main switch to confirm the selection.

Insert the relative access code and customise the parameters according to your requirements.

<b>Service Menu</b>	
Menu item	Description
Definition of zone	Zone Remote Panel sub menu settings
System defining	Sub menu to define the devices connected to the device
Device configuration	Sub menu to set the device's configuration
Factory settings	Default settings restore sub menu

<b>Service Menu -&gt; Definition of zone</b>			
Menu item	Description	Range	Customised value
Enable Room thermostat	Displays the enabling of the room thermostat control	Yes / No	
Room probe correction	Correction of room temperature read by panel sensor	- 3,0 ÷ + 3,0°C	
Modulating Room Probe	Modulation enabled with Room probe	Yes / No	
Room Antifreeze temp.	Room antifreeze activation temperature	0 ÷ 10 °C	
Enable dew point	Enabling setpoint correction by dew point calculation	Yes / No	

**Service Menu -> System defining**

Menu item	Description	Range	Customised value
External probe	Enables operation with the external probe	Yes / No	

**Service Menu -> Device configuration**

Menu item	Description	Range	Default	Customised value
Slave address	Address to configure according to the zone where the device is installed (e.g.: zone 1 = 41, zone 2 = 42, zone 3 = 43).	1 ÷ 247	41	
Baud rate	Communication speed	9600 / 19200	9600	
Parity bit	Parity bit	None / Even / Odd	Even	
Stop bits	Stop bits	0 / 1 / 2	1	

The device must be configured in accordance with the indications in the installation part of the technical documentation of the devices to which a Remote Panel can be connected.

## 11. TECHNICAL CHARACTERISTICS

- Dimensions (LxHxD):..... 128 x 98 x 36 (mm)
- Power Supply:..... 24V nominal (12V...24V)
- Maximum input:.....max 10 mA (max 250 mW)
- Functioning room temperature: ..... 0 - +50°C
- Warehouse temperature: ..... -10 - +60°C
- Protection rating according to EN 60730:..... II
- Protection rating according to EN 60529:..... IP 20
- Power supply electrical features:..... polarised bipolar cable
- Communication electrical features: ..... polarised bipolar cable
- Connection cable max. length: .....50 m (with cable 2x0.75mm<sup>2</sup>) (0.5 ÷mm<sup>2</sup> min - 1.5 mm<sup>2</sup> max)
- Precision indication room temp.: ..... +/- 0.5°C at 25°C\*
- Humidity probe accuracy:..... +/- 10%\*
- Clock indication diversion ..... +/- 15 minutes/year

\* = the indications of the room temperature and humidity can be affected by the point of installation of the Zone Remote Panel (e.g. hot wall, cold wall, height from the ground, etc.)

### 11.1 Product sheet.

In compliance with Regulation 811/2013, the class of the temperature control device is:

Class	Contribution to room central heating seasonal energy efficiency	Description
V	+3%	Zone Remote Panel
VI	+4%	Zone Remote Panel combined with external probe



This instruction booklet  
is made of ecological paper

Follow us

**Immergas Italia**



---

**immergas.com**

Immergas S.p.A.  
42041 Brescello (RE) - Italy  
Tel. 0522.689011  
Fax 0522.680617

**Certified company ISO 9001**



Cod. 1.045256ENG - Rev. ST.006268/001 - 10/23