

MAXIMUM USEFUL

Instructions and warnings **IE**

 **IMMERGAS**

# SMARTECH PLUS

Chrono-thermostat  
"SMART"

\*1.045008ENG\*



***Dear Customer,***

*Congratulations for having chosen a top-quality Immergas product, able to assure well-being and safety for a long period of time.*

*As an Immergas customer you can also count on a qualified after-sales service, prepared and updated to guarantee constant efficiency of your "SMARTECH PLUS" chrono-thermostat.*

*We would like to provide you with some important indications, your observance of which will ensure your satisfaction with the Immergas product:*

- *Read the following pages carefully: you will find useful suggestions regarding the correct use of the chrono-thermostat.*
- *For assistance and scheduled maintenance, contact "Authorised Technical After-Sales centres": they have original spare parts and are specifically trained.*

## INDEX

<b>1.</b>	<b>Installation.</b>	<b>4</b>
1.1	Application download and installation on mobile devices (smartphone).	4
1.2	Creating accounts.	4
1.3	Associating APP to smartech plus.	5
1.4	Registration.	7
<b>2</b>	<b>Device connected to a generator.</b>	<b>8</b>
2.1	Description of main screen (Fig. 13).	8
2.2	Selection of operating mode.	9
2.3	Room temperature setting.	9
2.4	Description of “programming” screen (Fig. 14).	9
2.5	Description of “weekly programming” screen (Fig. 15).	10
2.6	Description of “calendar definition” screen (Fig. 16).	10
<b>3</b>	<b>Chrono-thermostat (Fig. 17).</b>	<b>11</b>
3.1	Main screen.	11
3.2	Date and time setting.	11
3.3	Language setting.	13
3.4	Thermostat setting.	14
3.5	Curves setting.	15
3.6	Diagnostic setting.	16
3.7	Temperature setting.	16
3.8	Operating mode.	17
3.9	Set program.	18
3.10	Calendars program.	19
3.11	Set eco program.	21
3.12	Program ON.	21
3.13	Program OFF.	22
3.14	Mon-fri Program.	23
3.15	Sat-Sun Program.	24
3.16	DHW Progr On.	25
3.17	DHW Progr Off.	25
3.18	Antilegionella program.	26
<b>4</b>	<b>Associating Smartech to Alexa.</b>	<b>27</b>
4.1	Alexa account Association procedure.	27
4.2	Control with voice commands.	29
<b>5</b>	<b>Away Function.</b>	<b>30</b>
5.1	Function details.	30
5.2	Settings.	30
5.3	Joining a Smartphone.	30
5.4	Removing a Smartphone.	30
5.5	Turning Away mode on.	31
5.6	Range away.	31
5.7	System geolocation change.	31

## 1. INSTALLATION.

### 1.1 APPLICATION DOWNLOAD AND INSTALLATION ON MOBILE DEVICES (SMARTPHONE).

Using the mobile device on which to install the application, connect to the App store of reference: App Store (Apple) or Play Store (Android) and type in "Immergas Smartech" in the search field.

The app works with IOS 8 operating system or higher (Apple) and Android 6 or higher.

### 1.2 CREATING ACCOUNTS.

Start the "Smartech" app.

The following screen appears on the display of the mobile device when the app starts up, allowing you to login (Fig. 1), or to create a new account (Fig. 2).

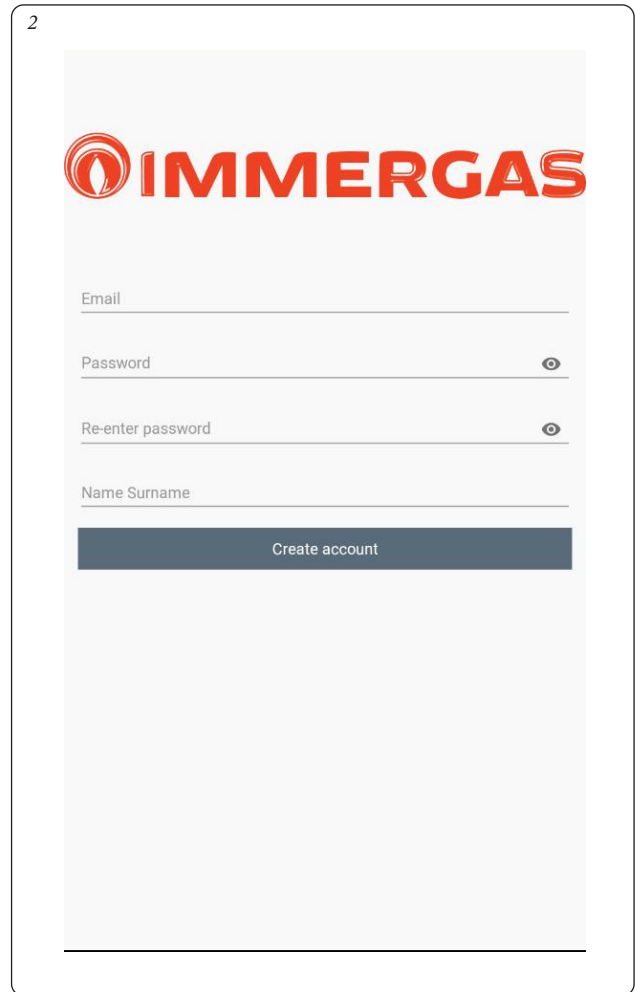
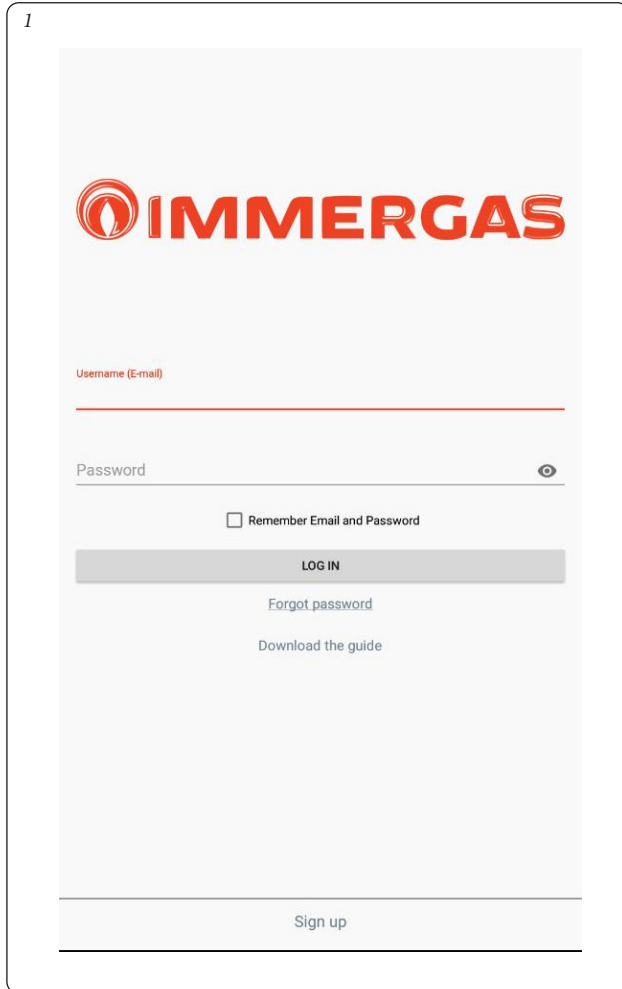

- Enter a valid email address.
- Enter a password which will then be used to access the registered account.
- Enter the password again to confirm the one previously entered.
- Enter name and surname.
- After entering the requested data, press "Create account".

Within a few minutes, you will receive an email at the address entered during creation of the account containing a code.

Enter this code in the appropriate field in the app and confirm by pressing "Create account".

### 1.3 ASSOCIATING APP TO SMARTECH PLUS.

**N.B.:** before this, make sure you have the password and the Wi-Fi network you want to connect to and make sure that this network has an Internet connection. Do not use a hotspot when associating the app.

Make sure that your Smartphone is connected to this network.

- power the Gateway and check that the batteries have been inserted in the chrono-thermostat, wait a couple of minutes;
- quickly press the “Reset” button 5 times. The "Cloud" and "Ble" LEDs will light up together;
- the Gateway turns off and on again;
- when the two LEDs "Cloud" and "Ble" flash together once per second, the Gateway is in Smarttech\_config\_AP mode.

**N.B.:** if you have already connected the Gateway to your account, but want to change the Wi-Fi connection to which you are connected, simply repeat the 4 points above. Then select one of the Chrono-thermostats associated to the Gateway you want to reconfigure by changing the password through the App, select "Configuration", "WIFI NETWORK CONNECTED" and press "UPDATE". Select "Smarttech\_config\_AP" and choose the network which you want to connect the Gateway to.

Open the “Smarttech” App, login, the message “No device has yet been added” will appear, press “+” at the bottom right. Execute the displayed requests and select “Smarttech\_config\_AP”.

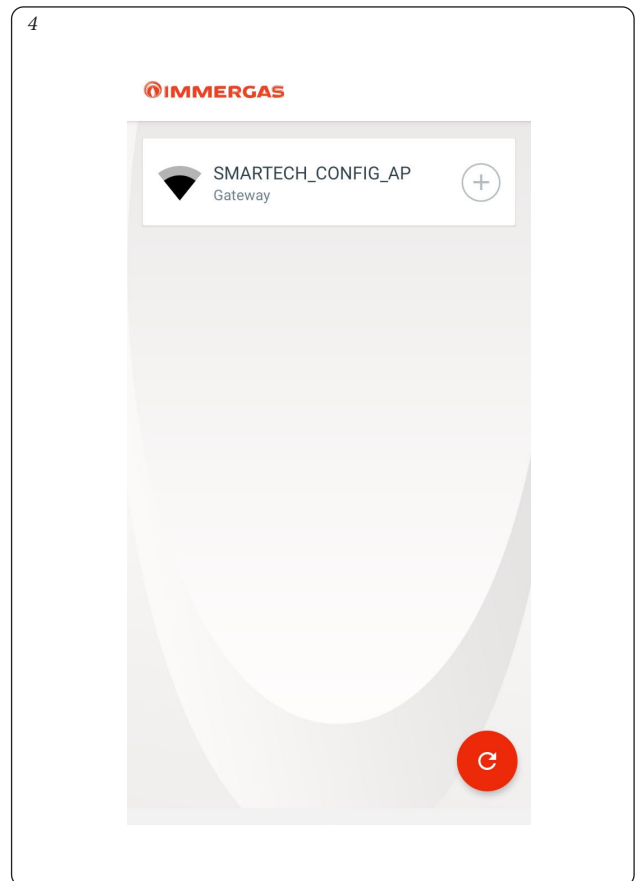
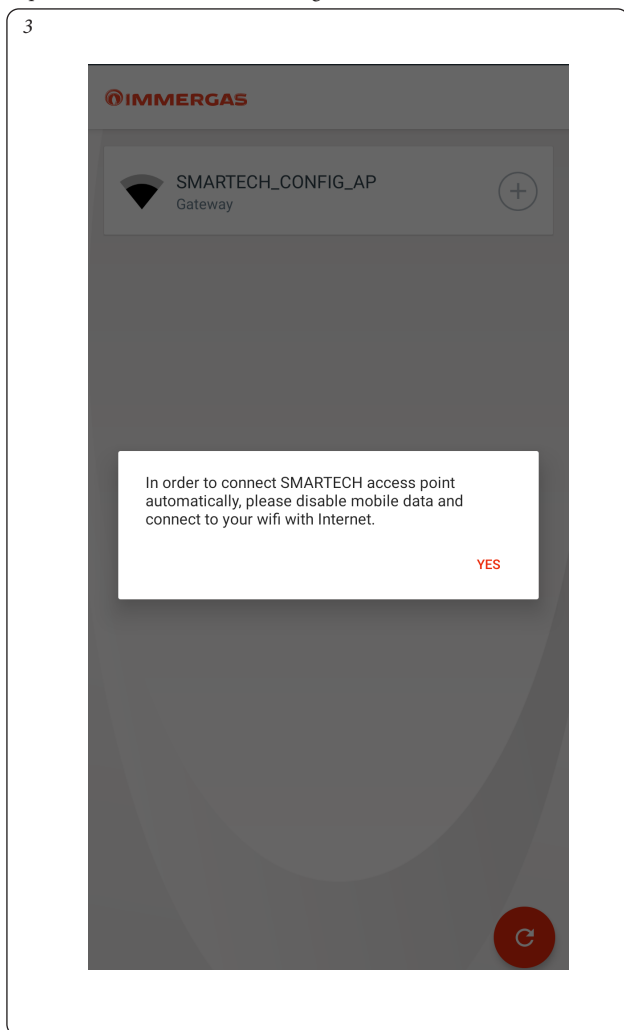

- Select the generator model from the proposed list (Fig. 5). The name is shown on the generator control panel (see example Fig. 6) or on the data nameplate (Ref. 1, Fig. 12).

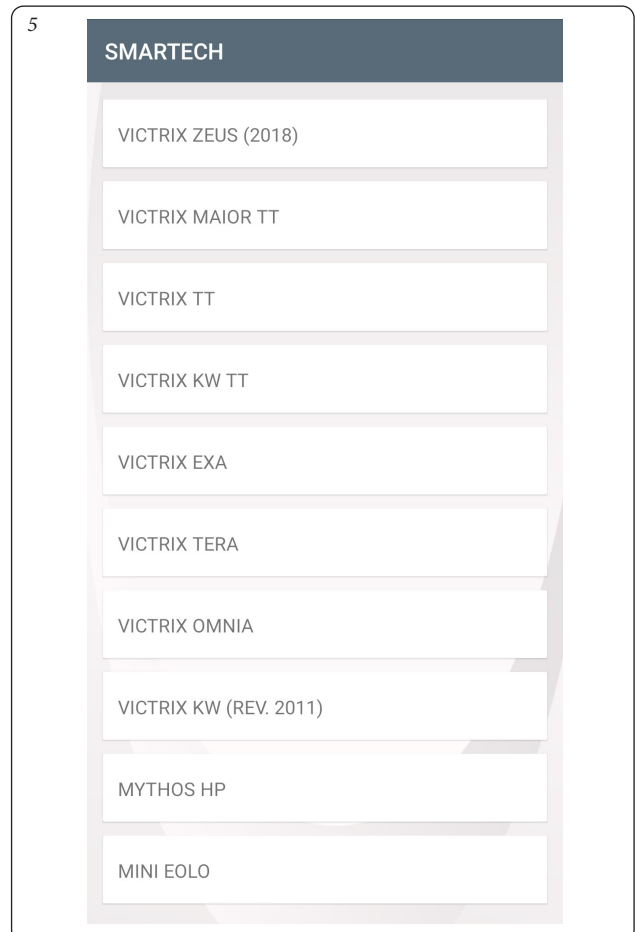



**N.B.:** by selecting “Other Immergas boilers”, only the “room thermostat” will operate.

Choose the Wi-Fi network you want to connect the Gateway to and write the correct password. After connection to the Cloud, a message will appear of the presence of a new Smartech Plus, press “Next” and write the name you want to give to your Chrono-thermostat (Fig. 7). Complete the installation by following the wizard.

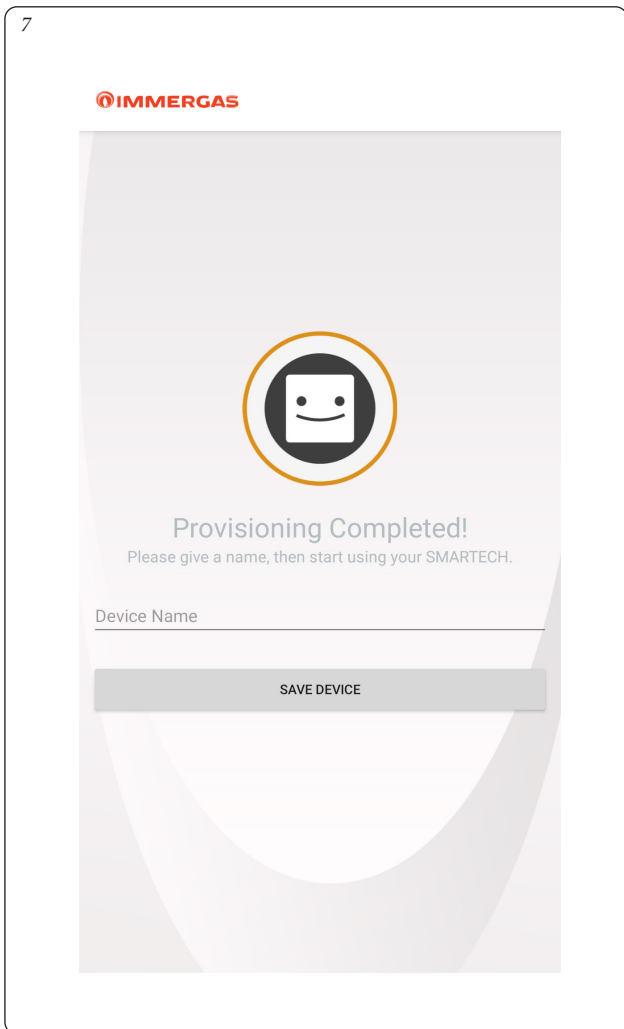

**N.B.:** if no device is found, perform the manual configuration procedure (Fig. 8 and 9). If a warning appears on the telephone of no Internet connection, press “maintain WI-FI connection” (Fig. 10).

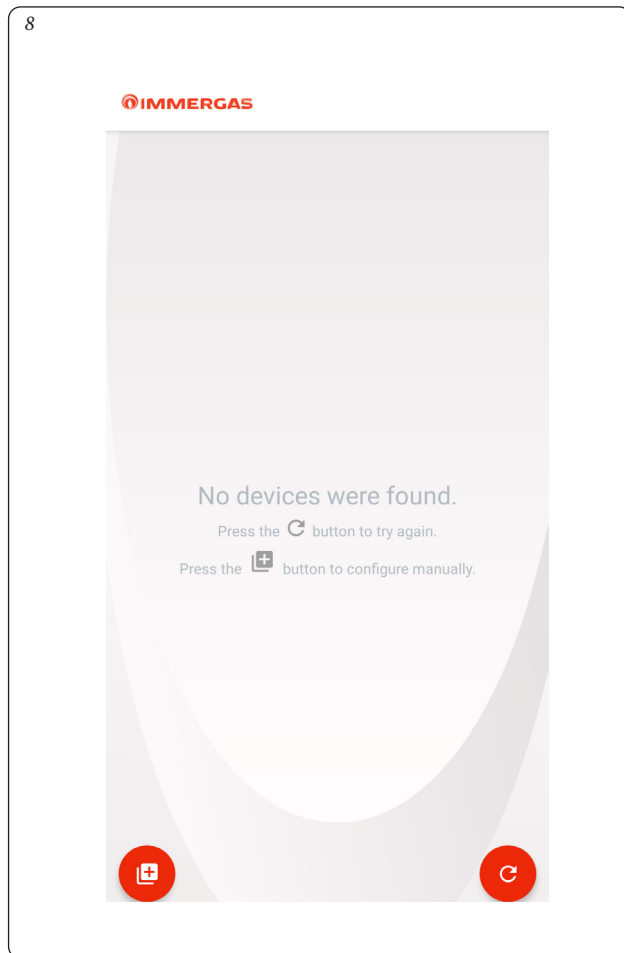

10

## Internet may not be available

If you stay connected to this Wi-Fi network now, your phone will also stay connected whenever you use this network in the future.

Keep Wi-Fi connection

Disconnect

### 1.4 REGISTRATION.

To complete the pairing procedure of Smartech Plus with an Immergas generator, the following registration screen will appear where you must fill in the Form to identify the system and customer.

11

SMARTECH

Registration

**Generator and device identification**

Type of generator\*  1

Generator serial no.\*  2

Generator serial no. check digit\*  3

Device's mac address \*

**Customer data**

Name\*  4

Surname\*

Phone\*  5

Province and Postcode\*  6

Nation\*  7

Email\*  8

**Acceptances**

Privacy\*  9

The personal data entered may be processed by Immergas S.p.a for marketing purposes and the forwarding of promotional and information material

Enables remote access  10

Enables remote access to the Immergas Authorized Assistance Center for maintenance

CONTINUA

Ref	Description
1	Generator model previously selected from the list (Fig. 5)
2	Enter the generator serial number (Ref. 2, Fig. 12)
3	Enter the generator serial number control code (Ref. 3, Fig. 12)
4	Enter name and surname
5	Enter your phone number
6	Select province and Post Code where the system is installed
7	Select country where the system is installed
8	Enter a valid email address
9	Privacy
10	Enable remote access: select to allow the authorised technical after sales centre to perform remote operations on the generator.

- Enter the generator serial number (Ref. 2, Fig. 11) applied on the generator data nameplate (Ref. 2, Fig. 12).
- Enter the generator serial number control code (Ref. 3, Fig. 11) applied on the generator data nameplate (Ref. 3, Fig. 12).

12
1
3

IMMERGAS S.p.A via Cisa Ligure 95,  
42041 Brescello RE - ITALY

Md. **VICTRIX TERA 24** Cod.Md. **3.027368** IT 12-RSP  
 Sr. N° **XXXXXX** CHK **X** NG 24 (G20 -20 mbar) CONDENSAZIONE ES 12-RSP  
 IT 12-RSP

Type C13-C33-C43-C53-C83-C93 B23-B53p

Q<sub>net</sub>Gn min 4,5 Q<sub>net</sub>Gn max 28,8(24,6) Pn min 4,3 Pn max 28,3(24,1)

PMS 3 bar PMW 10 bar D 13,7 l/min TM 90°C

NOx Class 6 IPXSD 230 V - 50 Hz 80 W

CE 0476 XX 2

PIN.

- Then enter the other data required by the registration form.
- Select “Enable remote access” (Ref. 10, Fig. 11) to enable the Authorised Technical After Sales Centre to perform remote operations on the generator.
- At the end press “Continue”.

## 2 DEVICE CONNECTED TO A GENERATOR.

Operation of a generator connected to Smartech Plus can be modulated or On/Off type depending on the paired generator model and the type of electrical connection made (see installation instruction leaflet).

If the connection between the Smartech Plus Gateway and the generator is made via IMG Bus (only enabled models), it will be in modulated operation and the generator display will show the remote control symbol (see installation instruction leaflet).

Otherwise if the connection is made via the room thermostat (TA) contact, operation will be the ON/OFF type.

- **On/Off operation:** Smartech Plus allows you to set, using the Chrono-thermostat or the App, the desired room temperature and the operating mode: manual or automatic, according to the set weekly programming. The flow temperature will be kept constant until the desired room temperature is reached.
- **Modulated operation:** the flow temperature will be changed by adjusting it to the actual needs of the room being heated, in order to obtain the desired room temperature with extreme precision and therefore with evident saving in costs. In this mode, in addition to the settings available in On/Off mode, Smartech Plus acts a remote control and, by means of the Chrono-thermostat or the App, you may intervene on the main parameters, such as flow and domestic hot water temperature and view any error codes. The control panel of the generator is disabled; however the reset button, the shutdown button (Off only) and the display showing the operating status remain active. Furthermore operation with external probe (see paragraph 3.5) and, when paired with boilers with storage tank unit, the domestic hot water programming (see paragraphs 3.14 to 3.18) are enabled.

**N.B.:** a few seconds can pass from when any parameter is set from the mobile device before seeing it on the chrono-thermostat and/or on the generator.

## 2.1 DESCRIPTION OF MAIN SCREEN (FIG. 13).



Ref	Description
1	Operating mode (STAND-BY / DHW / DHW + COOLING / DHW + C.H.).
2	List and selection of connected devices (max. 18 devices).
3	Screens selection button (CONFIGURATION / INSTRUCTIONS AND WARNINGS / ADD NEW DEVICE / LOGOUT).
4	Central heating or cooling demand in progress.
5	Measured room temperature display.
6	Displays current weather forecast and outdoor temperature.
7	Temperature and operating mode display: - <b>Auto</b> , follows hourly programming set by the user; - <b>Auto/Man</b> , starting from automatic (Auto) mode, it follows any changes in room temperature made using the knob (Ref. 9, Fig. 13) until that the next scheduled time slot. - <b>Manual</b> , maintains the room temperature set with the knob (Ref. 9, Fig. 13).
8	Faults display (not available for generators connected to room thermostat).
9	Knob to set room temperature.
10	Schedule screens access button.
11	Manually refreshes data.



## 2.2 SELECTION OF OPERATING MODE.

The buttons (Ref. 1, Fig. 13) allow you to select the following operating modes: OFF, Summer, Winter, Cooling.

**N.B.:** the room antifreeze function is active in the modes: OFF, winter.

- **Off mode** (OFF). This mode guarantees the room antifreeze function.
- **Summer mode** (☀️). In this mode the system is enabled for producing domestic hot water excluding space central heating.
- **Winter mode** (❄️). In winter mode the system is enabled for producing domestic hot water and for space central heating. The room temperature is maintained constant at the set value.
- **Cooling mode** (❄️❄️). In cooling mode the system is enabled for the DHW production and to control an outdoor condensing unit (only for models set-up) for space cooling.

**N.B.:** After selecting the operating mode, wait for the symbol to turn red confirming that the generator has made the change.

## 2.3 ROOM TEMPERATURE SETTING.

To set the desired room temperature, simply rotate the knob (Ref. 9, Fig. 13) on the main screen. The screen will show, in real time, the room temperature set (Ref. 7, Fig. 13).

Any room temperature from +4,5°C to +30°C can be selected, which will be kept constant until new adjustments are made or a different mode is selected.

## 2.4 DESCRIPTION OF “PROGRAMMING” SCREEN (FIG. 14).

Press the “Programming” button (Ref. 10 Fig. 13) to access the “Programming” screen (see Fig. 14).

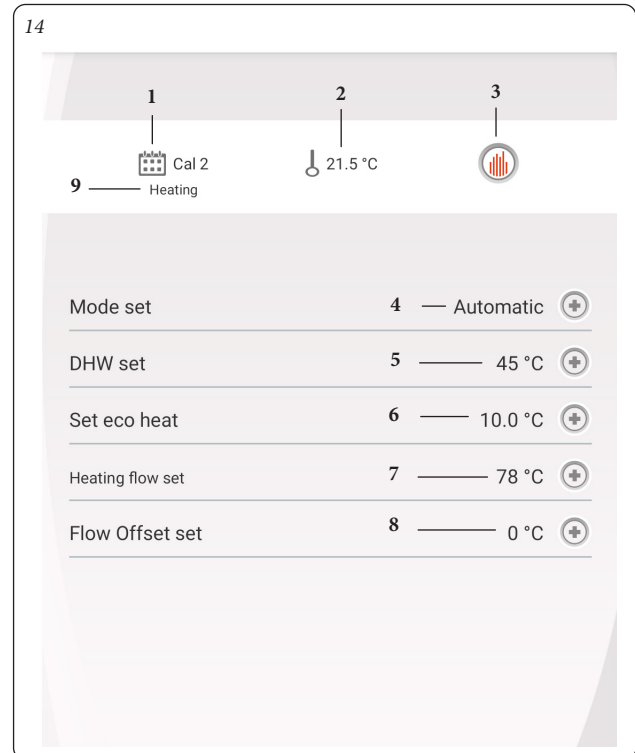

Ref	Description
1	Display of current calendar
2	Display of room temperature
3	Weekly programming setting or change
4	Setting automatic/manual mode: - <b>Auto</b> , follows hourly programming set by the user; - <b>Manual</b> , maintains the temperature set by the user with the knob (Ref. 9, Fig. 13)
5	DHW temperature setting (not available for generators connected to room thermostat)
6	- <b>Eco CH setting</b> : room temperature setting outside of the programmed time slots of the calendar in winter mode (central heating); - <b>Eco cooling setting</b> : room temperature setting outside of the programmed time slots of the calendar in cooling mode;
7	Maximum system flow temperature setting (not available for generators connected to room thermostat)
8	System flow temperature increase/decrease setting calculated by the system (not available for generators connected to room thermostat)
9	Display of operating mode associated to the current calendar: - <b>Central heating</b> , (winter operating mode); - <b>Cooling</b> , (cooling operating mode);

**2.5 DESCRIPTION OF “WEEKLY PROGRAMMING” SCREEN (FIG. 15).**

**Clock and programs.**

This screen allows you to set the time slots and relative room temperatures. Access this screen by pressing the button (Ref. 3, Fig. 14).

- **Time slots.** Smartech Plus allows you to set 4 calendars with 4 operating time slots and relative room temperatures. Outside of these 4 time slots, the system will run maintaining the temperature set in the parameter “Eco room temperature setting” (Ref. 6, Fig. 14).

After setting these 4 calendars it is possible to associate them to the various days of the week (Ref 2, Fig. 15).

- Having entered the menu by pressing “Cal. n.” (Ref. 1, Fig. 15) you access the screen to define the switch on/off intervals (Fig. 16).
- When you’ve finished programming a calendar, pressing the go back to previous screen button allows you to program any other available calendars.

**N.B.:** The calendars associated to “Central heating” (winter operating mode) or “Cooling” (cooling operating mode) are different. To view them and to set them, first select the relative operating mode.

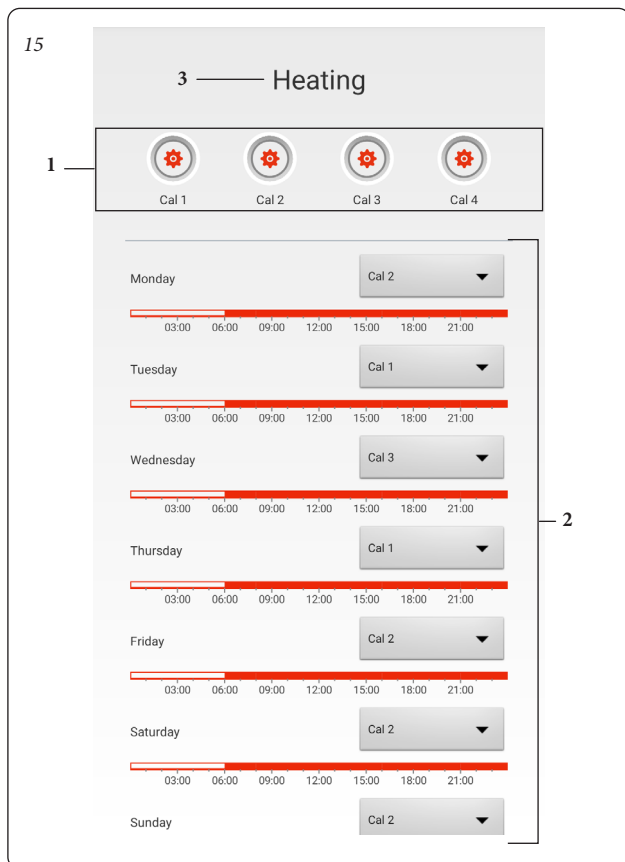

Ref	Description
1	Calendar definition buttons
2	Definition of calendar associated to each day of the week
3	Display of operating mode associated to the current calendar: - <b>Central heating</b> , (winter operating mode); - <b>Cooling</b> , (cooling operating mode);

With generator paired to a storage tank unit, you may program heating from the thermostat (see paragraphs 3.14, 3.15, 3.16, 3.17 and 3.18).

**2.6 DESCRIPTION OF “CALENDAR DEFINITION” SCREEN (FIG. 16).**

**Clock and programs.**

This menu allows you to set the time slots and relative room temperatures.

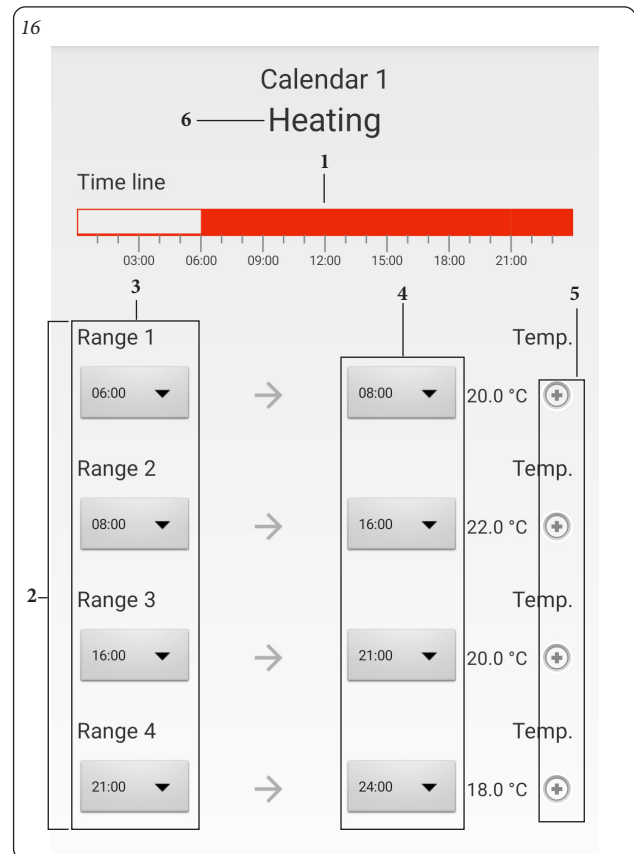

Ref	Description
1	Display of set intervals
2	Ignition intervals
3	ON - definition of interval starting time
4	OFF - definition of interval end time
5	Interval temperature setting
6	Display of operating mode associated to the current calendar: - <b>Central heating</b> , (winter operating mode); - <b>Cooling</b> , (cooling operating mode);

**N.B.:** to exclude use of one or more time slots, simply set the same start and end time.

### 3 CHRONO-THERMOSTAT (FIG. 17).

#### 3.1 MAIN SCREEN.

The external body of the thermostat is either a button or adjustment knob.

#### Navigation operations.

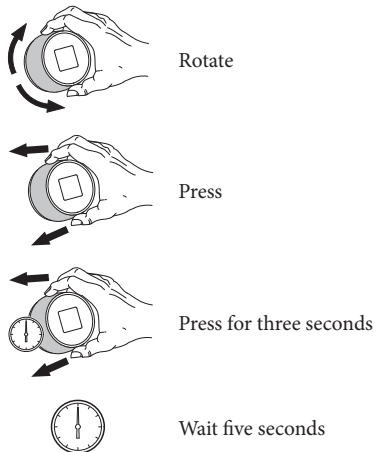

It is possible to set the temperature both locally (from the thermostat) and remotely from the App.

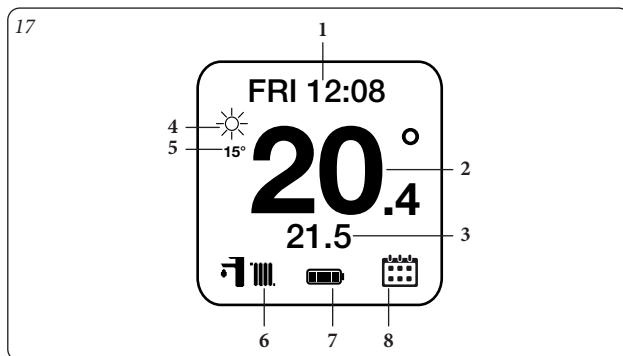

Ref	Description
1	Text message (for example: date, connection status, error)
2	Detected room temperature
3	Set room temperature
4	Weather (if connected to internet)
5	Outdoor temperature (if connected to internet)
6	STAND-BY operating mode
	SUMMER operating mode
	WINTER operating mode
	COOLING operating mode
7	Battery level 100%
	Battery level 75%
	Battery level 50%
	Battery level 25%
	Battery flat
8	Automatic mode with programming
	Temporary manual mode (until next time slot)
	Manual mode

#### 3.2 DATE AND TIME SETTING.

Date: you may set the date and time.

If A is displayed, the time and data are set automatically from Internet.

N.B.: check that the date and time are entered correctly to guarantee proper operation of the calendars.

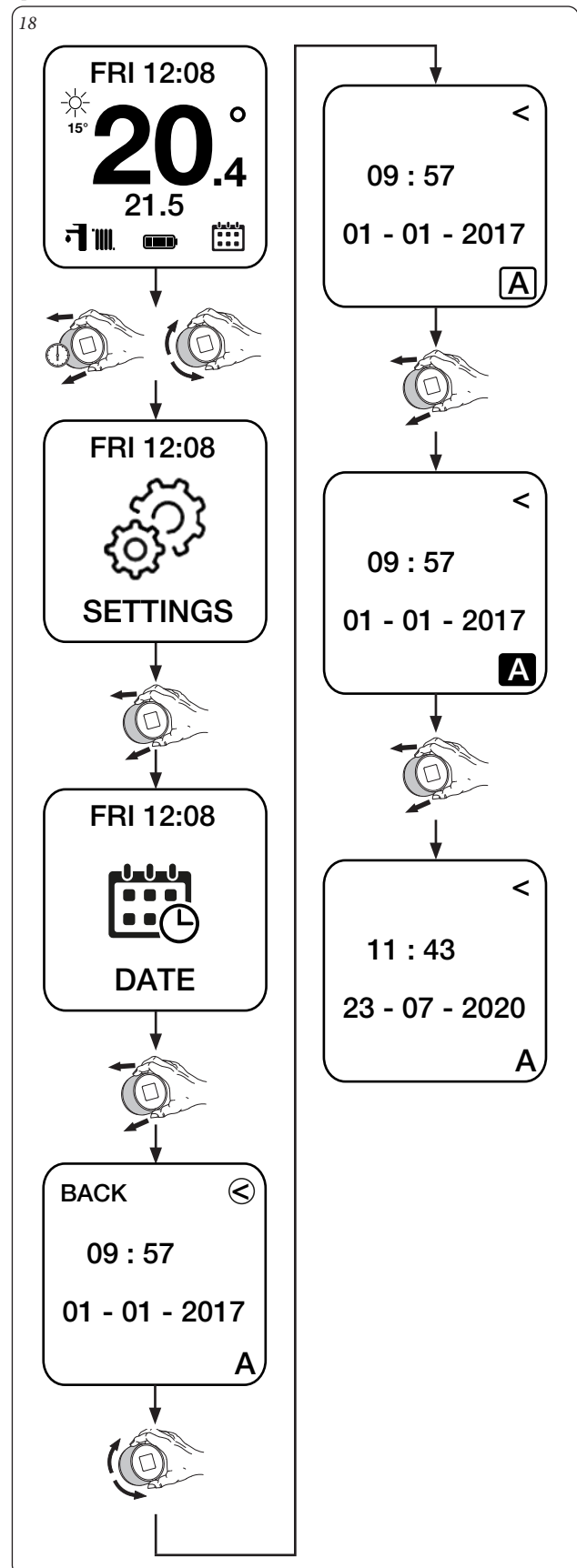

If the chrono-thermostat is not connected to the Internet, you must enter the M mode, to manually set the current time and date.

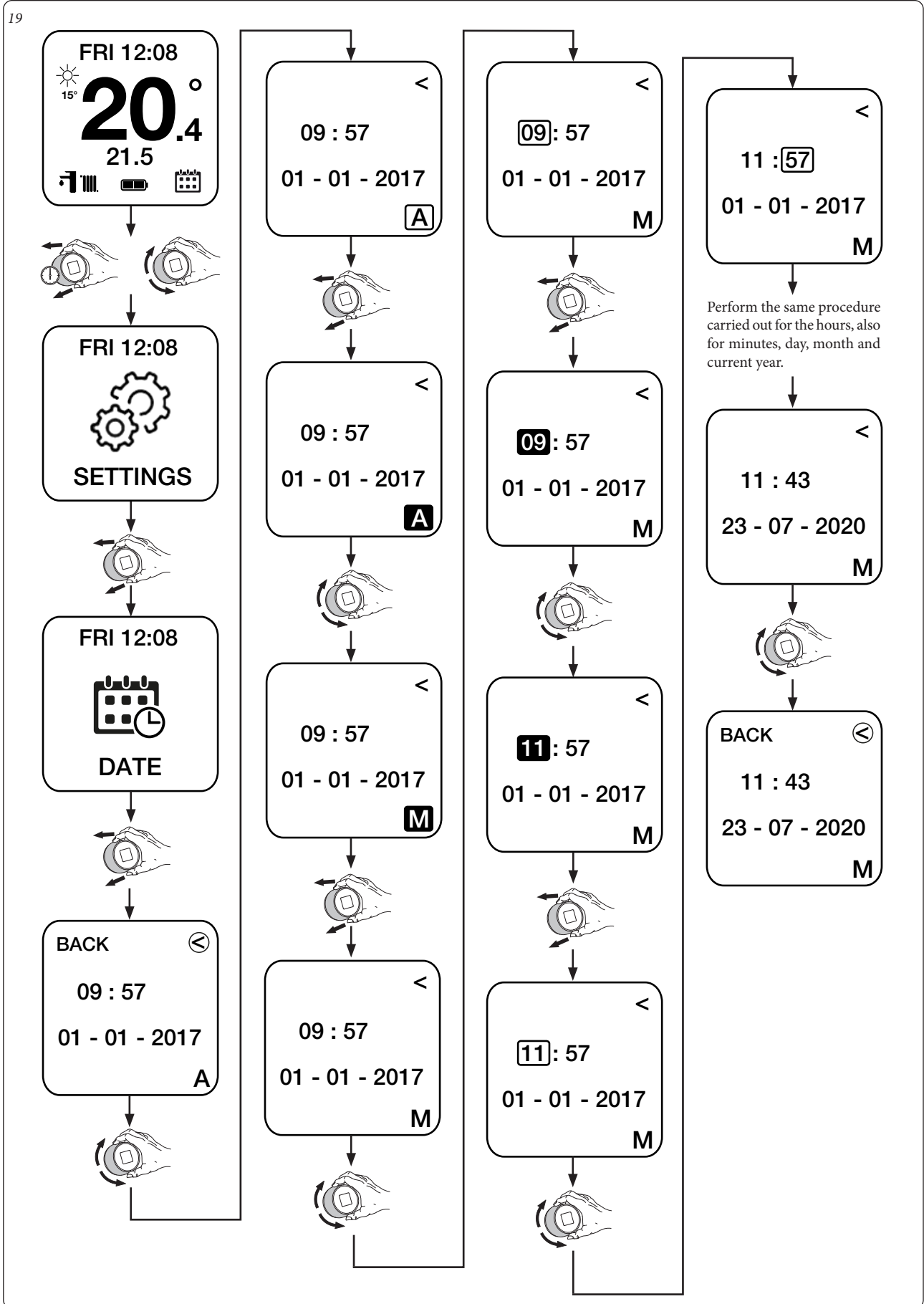

### 3.3 LANGUAGE SETTING.

**Language:** to set the language of the chrono-thermostat (Italian, English, French, Spanish, German, Russian).

20

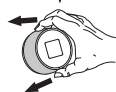
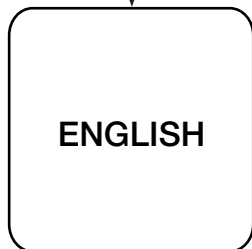
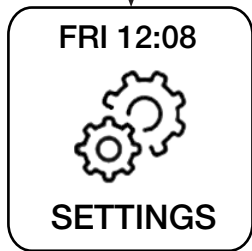

3.4 THERMOSTAT SETTING.

Thermostat (only with IMG Bus): you may set the “Maximum system flow temperature” and the “DHW temperature”.

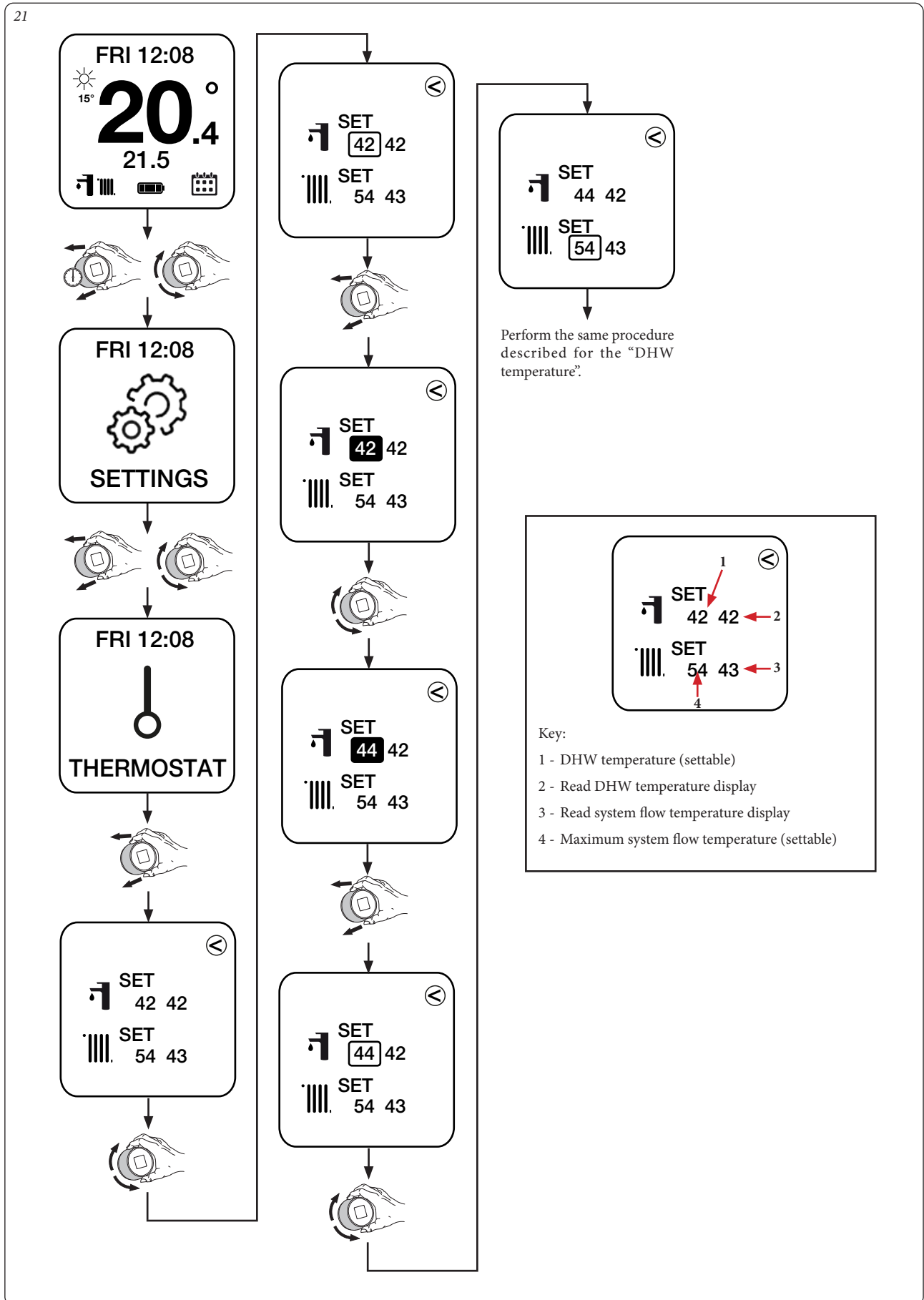

### 3.5 CURVES SETTING.

**Curve (only with IMG Bus):** you may enable/disable operation with external probe and eventually it is possible to set the values that define the operating curve with external probe.

**N.B.:** by default, the thermostat is supplied with operation with external probe enabled.

The curve displays the correction law of the flow temperature. Function of the outdoor temperature and of the position of the user heating temperature adjustment.

**N.B.:** the outdoor temperature used by default is that taken from the Internet, otherwise, if envisioned by the generator, an outdoor probe can be installed on-site.

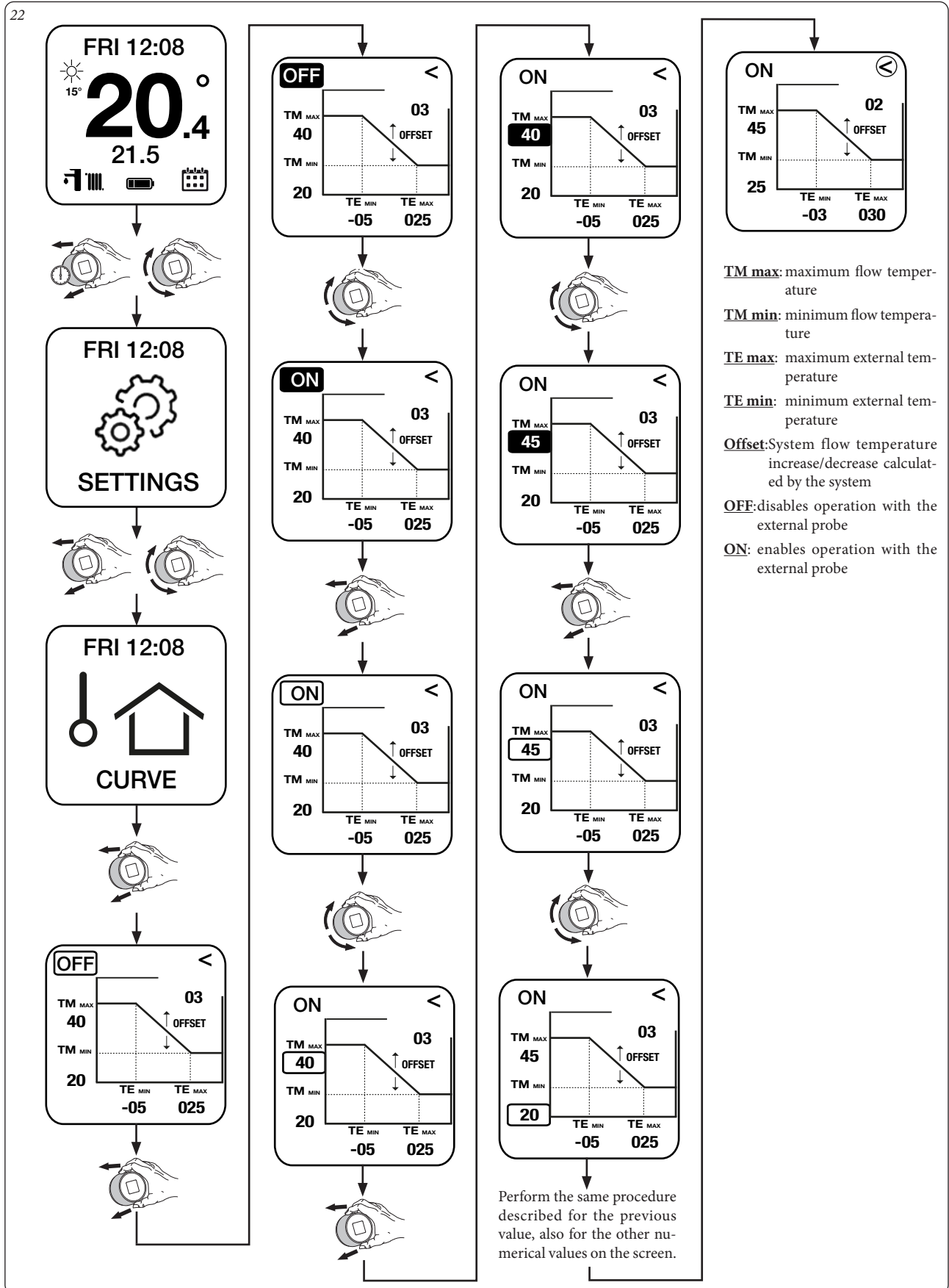

### 3.6 DIAGNOSTIC SETTING.

**Diagnostic:** you may view the information on the mac address, signal quality, bluetooth, connection status, battery level and hardware and software version.

It is also possible to change status from “Disconnected” to “Pairing” (only to be used when re-associating the chrono-thermostat to the Gateway).

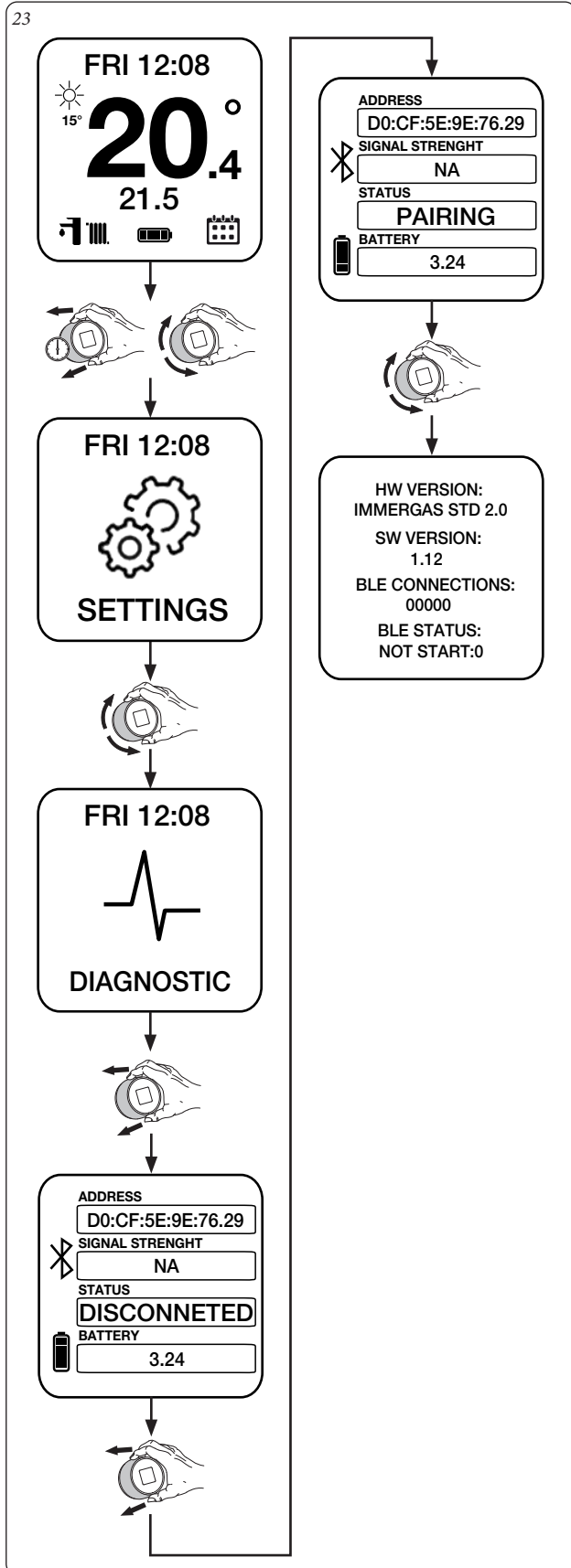

### 3.7 TEMPERATURE SETTING.

The desired room temperature can be set in the following ways.

#### Automatic mode with programming.

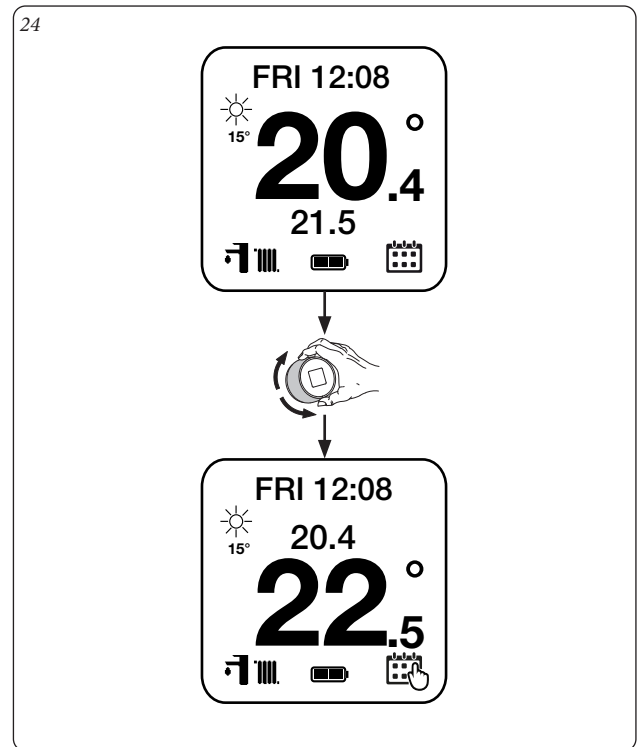

N.B.: the temperature set in Fig. 24 is the “forced manual” mode (the set temperature remains active until the next scheduled time slot).

#### Manual mode.

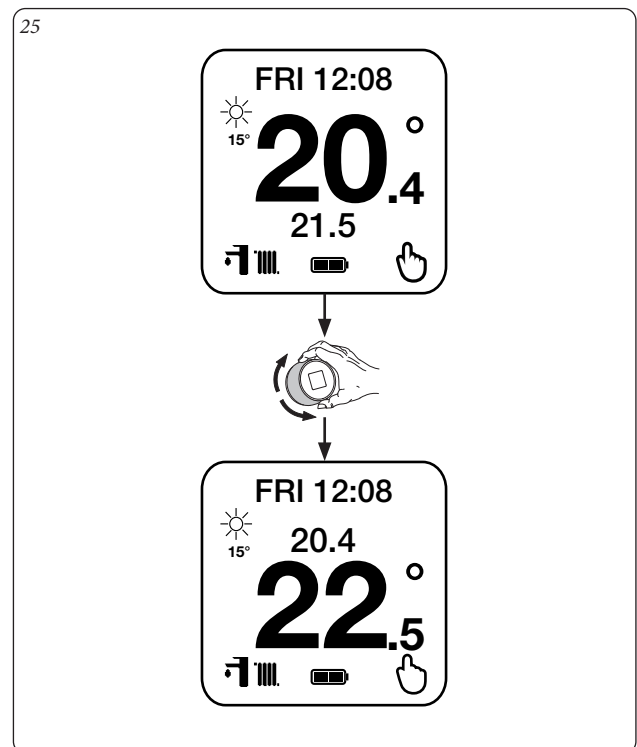

N.B.: the temperature set in Fig. 25 remains active until the next change.



3.8 OPERATING MODE.

Mode: to define the operating mode of the generator (see Paragraph 2.2).

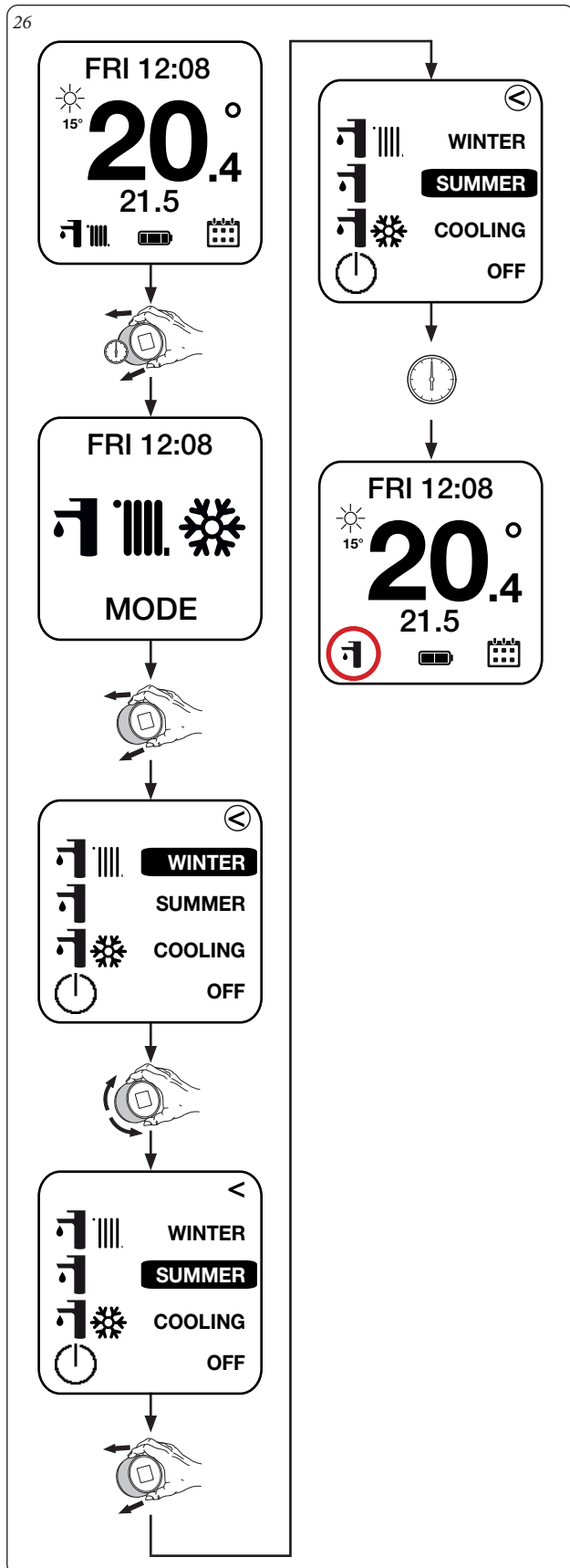

### 3.9 SET PROGRAM.

**Set:** allows you to program the various days of the week, associating them to one of the stored calendars.

27

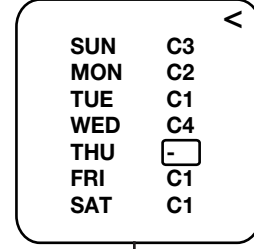
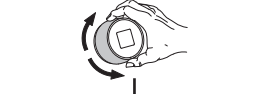
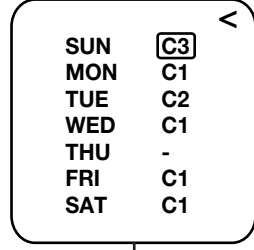
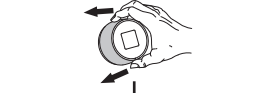
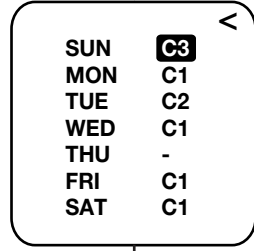
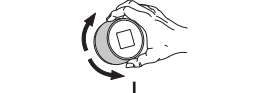
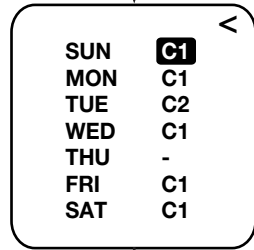
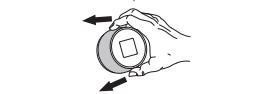
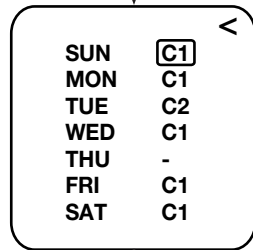
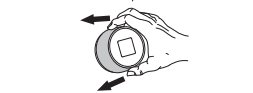
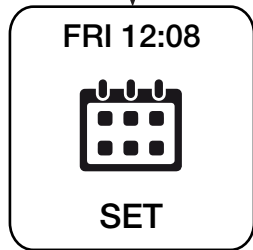
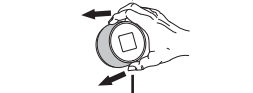

Perform the same procedure described for the previous value, also for the other values on the screen.

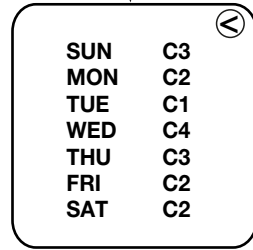

**3.10 CALENDARS PROGRAM.**

Cal1 - Cal2 - Cal3 - Cal4: to set the four time slots of the respective calendar selected.

N.B.: the same procedure is valid for all types of calendar(Cal1 or Cal2 or Cal3 or Cal4).

It is also possible to modify the time slots of the various calendars by changing the calendar at the top left of the chrono-thermostat (for example: CAL1 to CAL2) without needing to go back.

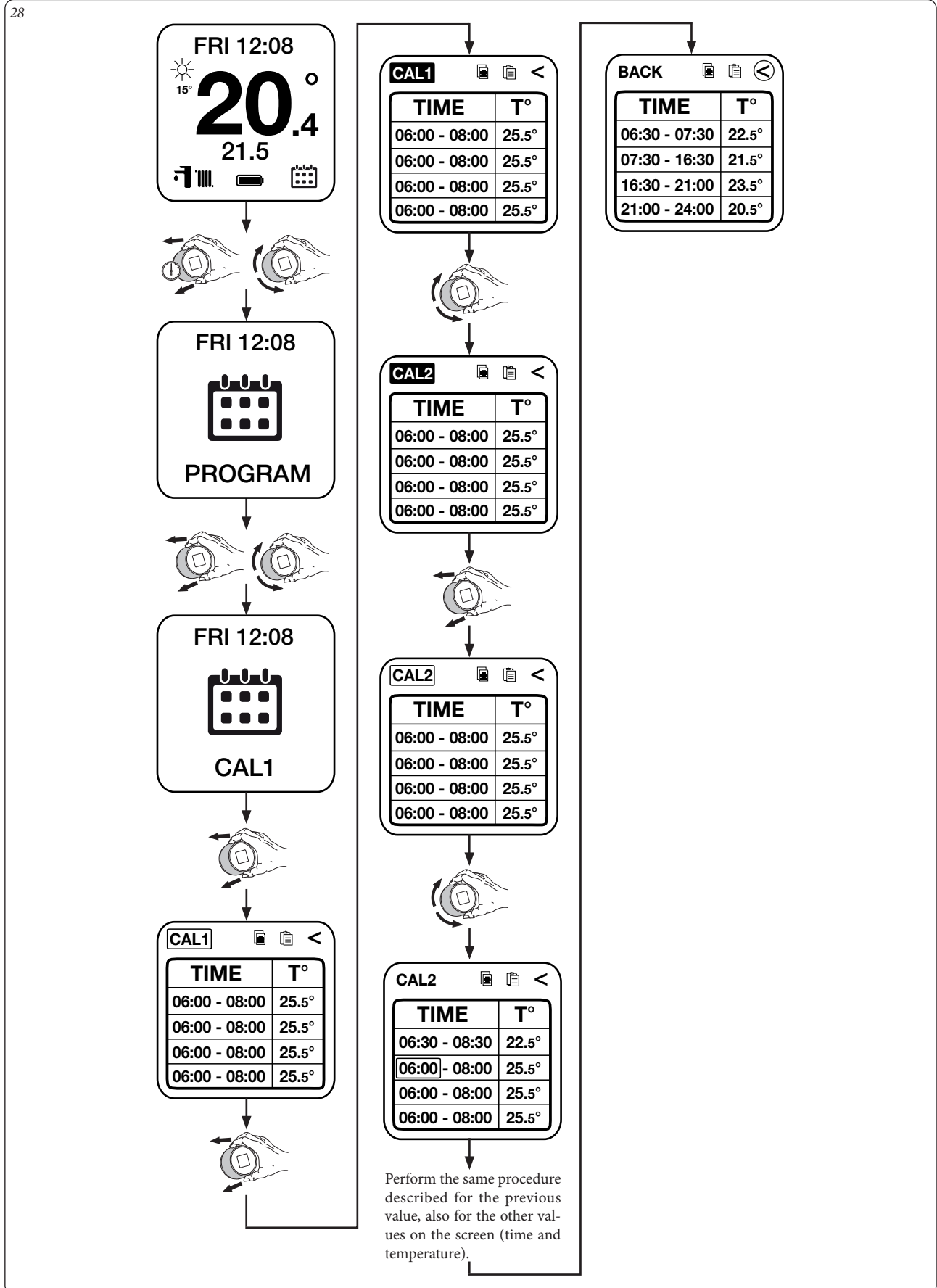

**Calendar “Copy” and “Paste” function.**

It is also possible to manually change the data of the various calendars, to copy the calendar already set (for example: Cal2) and to paste it onto another calendar (for example: Cal3).

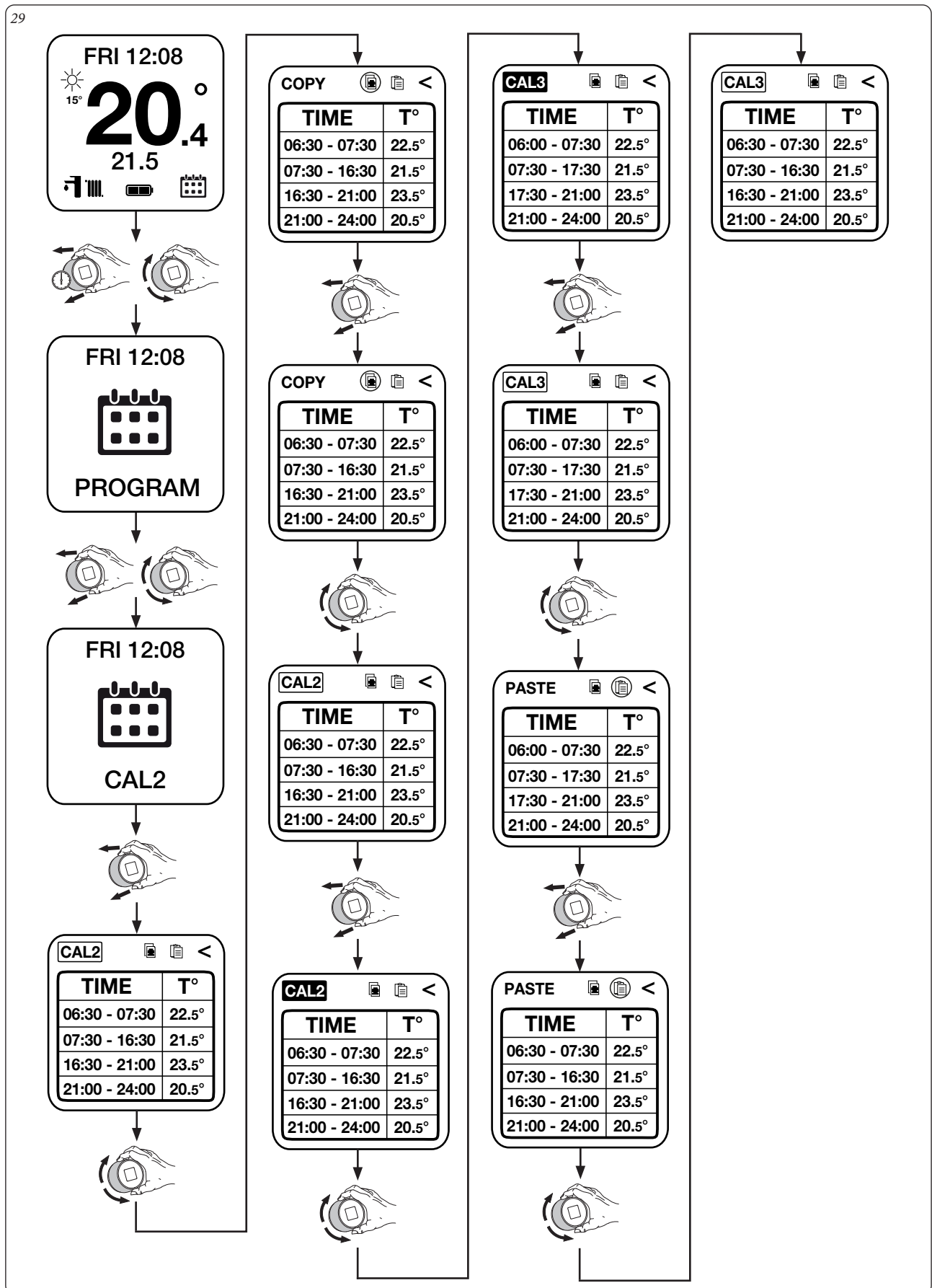

**3.11 SET ECO PROGRAM.**

**Set Eco:** allows you to set the room temperature outside of the programmed time slots of the calendar.

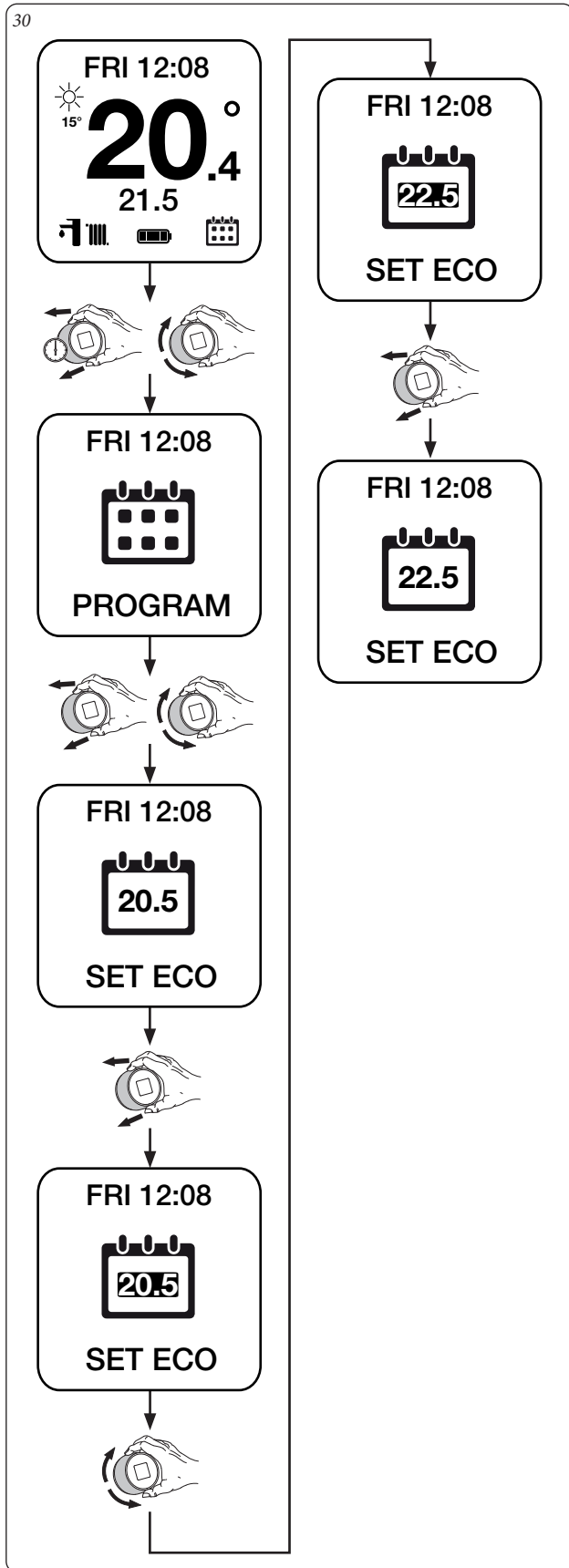

**3.12 PROGRAM ON.**

**Program On:** allows you to follow the hourly programming set by the user.

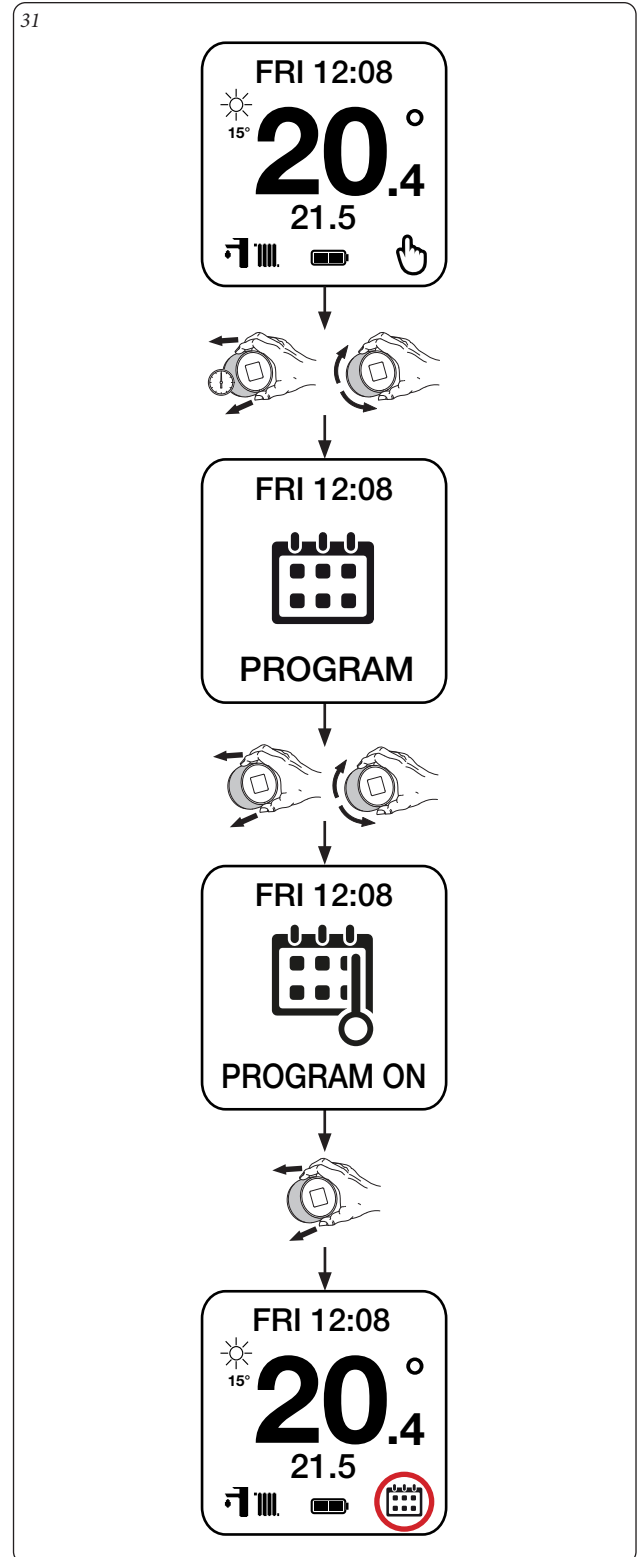

### 3.13 PROGRAM OFF.

**Program Off:** enables manual mode, keeping the room temperature set by the user.

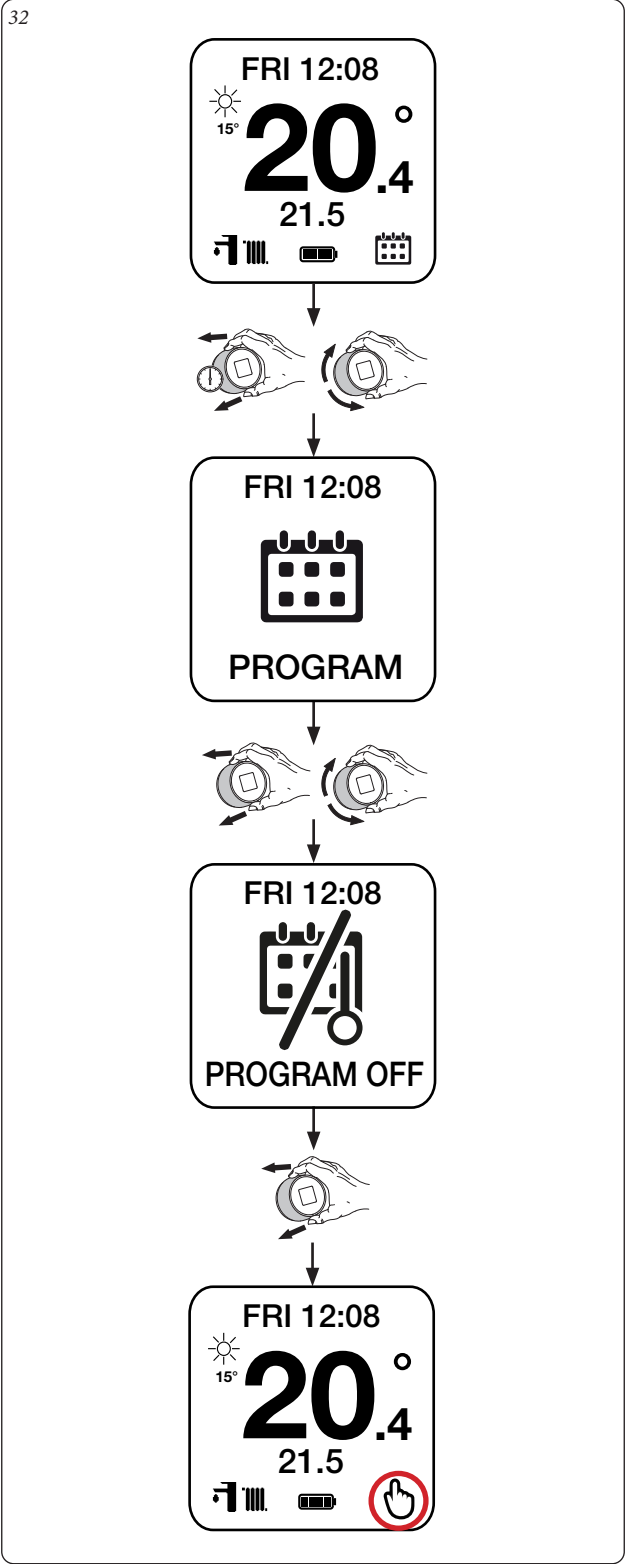

### 3.14 MON-FRI PROGRAM

Mon-Fri (only with IMG bus and boilers paired to storage tank unit): allows you to set the four time slots of the storage tank from Monday to Friday.

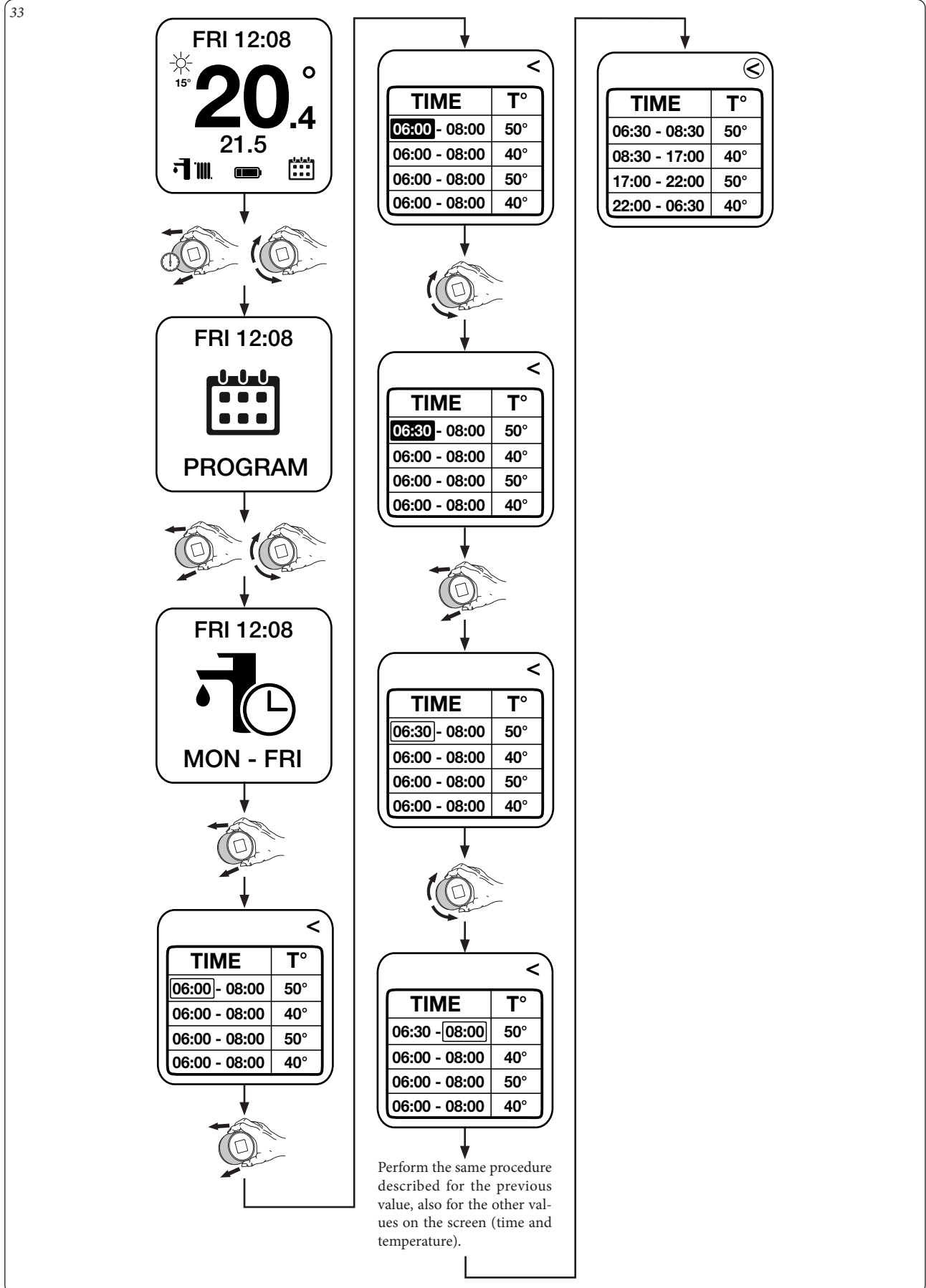

### 3.15 SAT-SUN PROGRAM

Sat-Sun (only with IMG bus and boilers paired to storage tank unit):  
allows you to set the four time slots of the storage tank on the weekend  
(Saturday and Sunday).

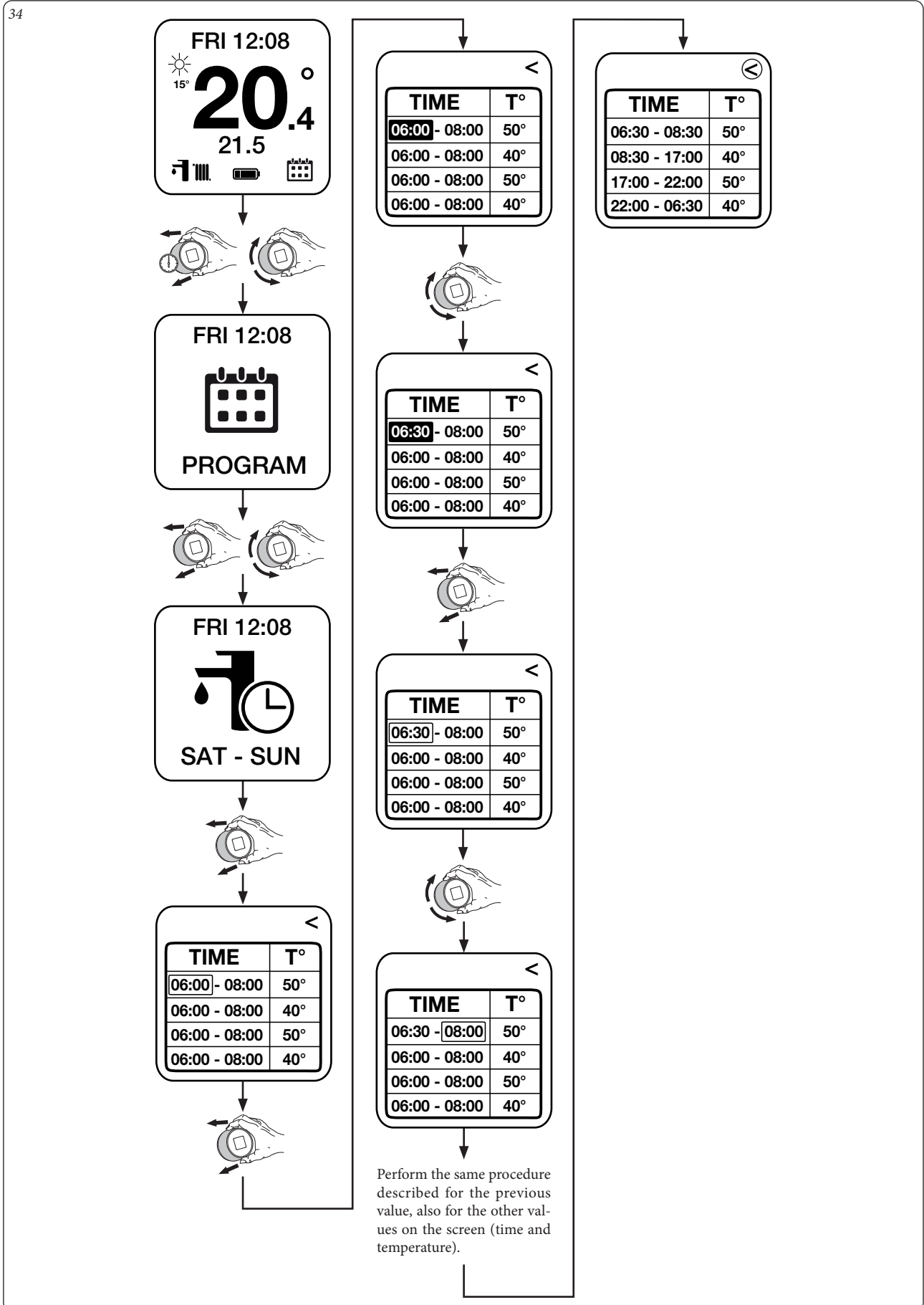



### 3.16 DHW PROGR ON.

DHW Progr On (only with IMG bus and boilers paired to storage tank unit): allows you to enable heating operation of the storage tank according to the DHW programming.

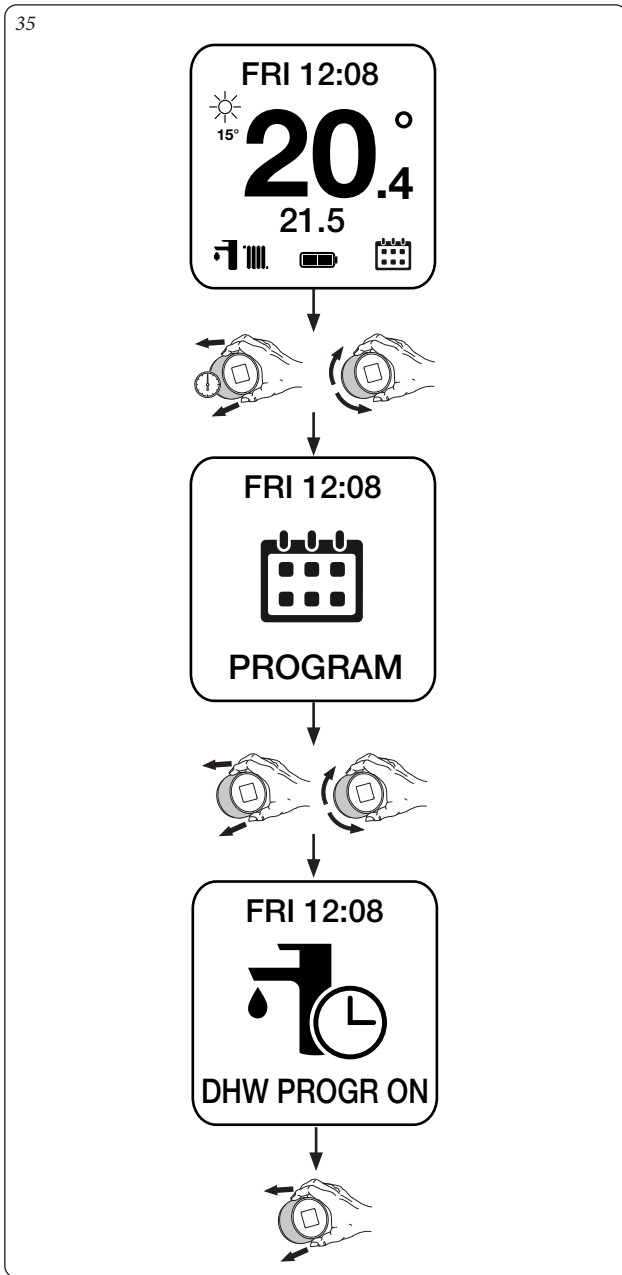

### 3.17 DHW PROGR OFF.

DHW Progr Off (only with IMG bus and boilers paired to storage tank unit): allows you to disable heating operation of the storage tank according to the DHW programming.

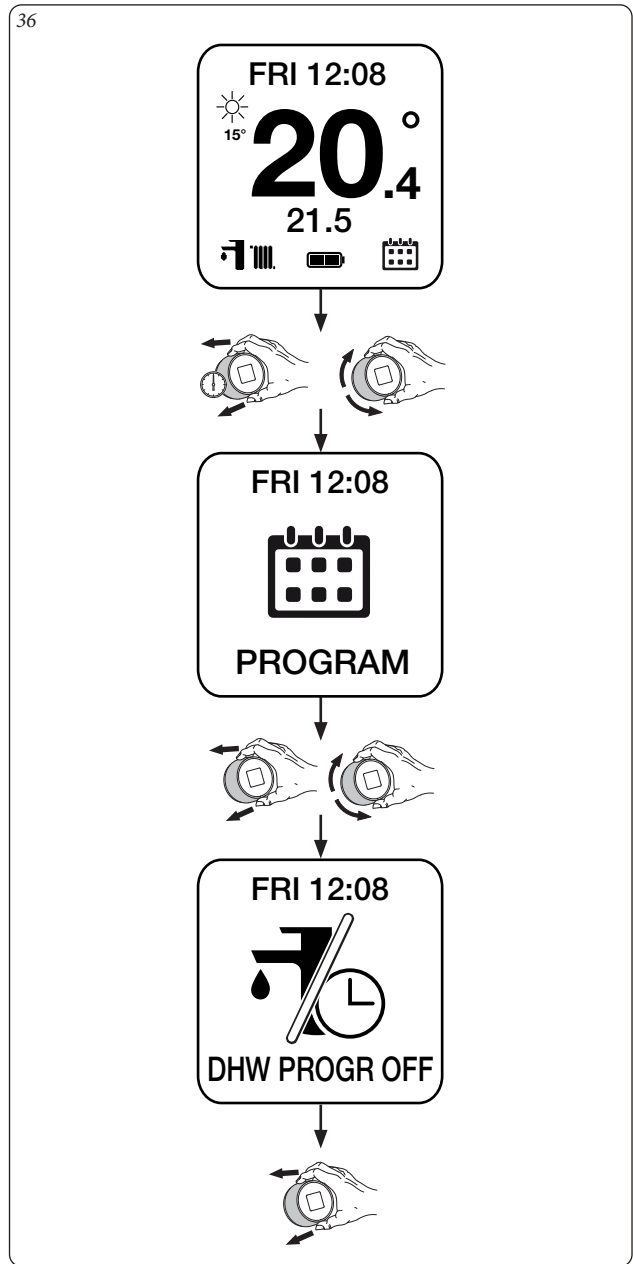

3.18 ANTILEGIONELLA PROGRAM.

Antilegionella (only with IMG bus and boilers paired to storage tank unit): allows you to set every how many days the generator heats the storage tank to 60° C (max DHW).

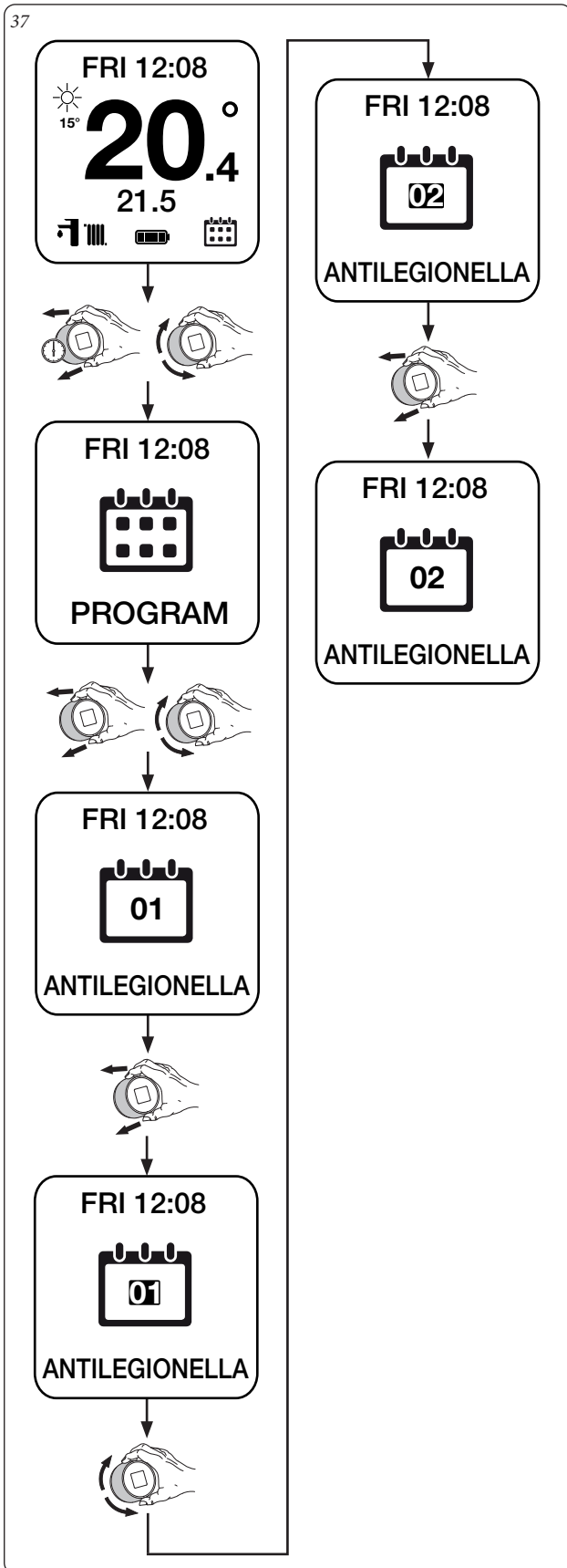

#### 4 ASSOCIATING SMARTECH TO ALEXA.

This procedure makes it possible to control the installations directly from Alexa via Smartphone or Smart Speaker.

##### 4.1 ALEXA ACCOUNT ASSOCIATION PROCEDURE.

Complete the installation procedure (Chapter 1).

Look for the Android/IOS Market on your smartphone and install the "Alexa" app.

Start the Alexa app and login with your credentials. If you do not have Alexa credentials, complete the registration by means of the same application.

Once you have logged into the Alexa application, look for the "Smartech" skill (Fig. 38) and enable it (Fig. 39).

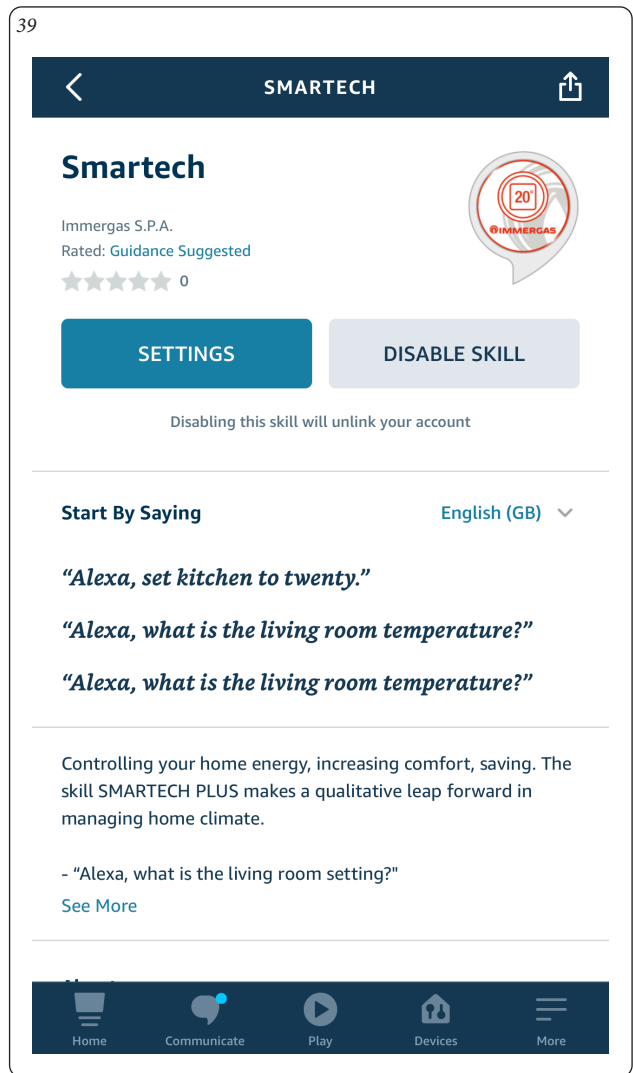
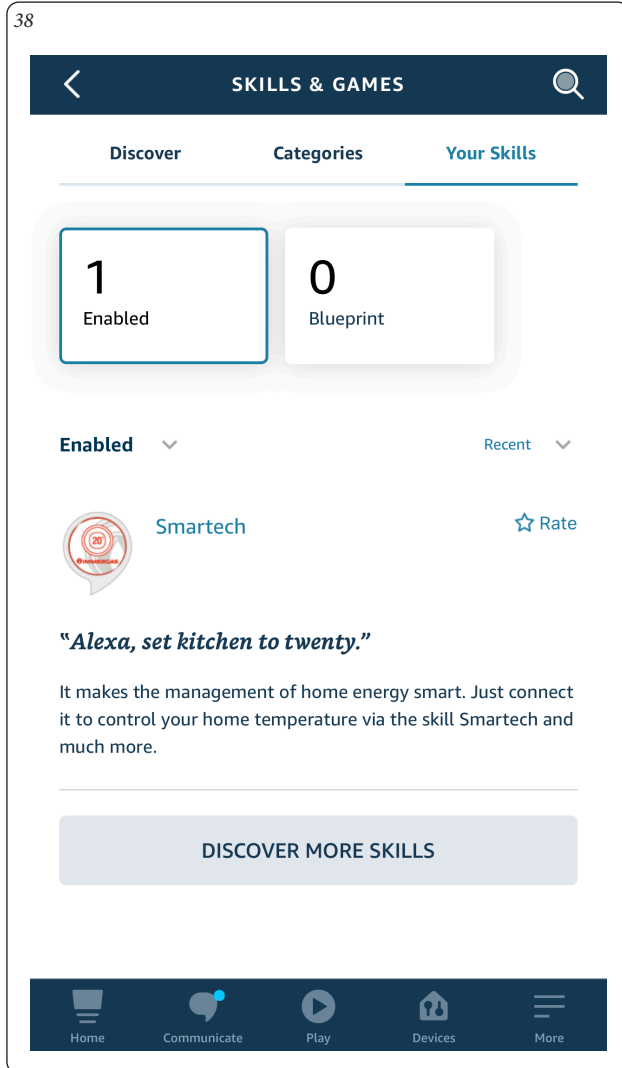

You will then be requested the credentials given when being registered on the Smartech app containing the Installations (Fig. 40). Wait for Alexa to connect the thermostats.

40

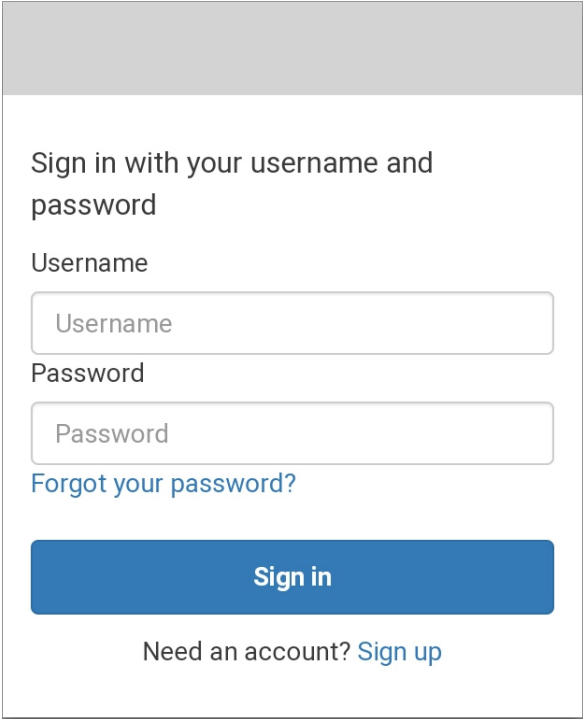

Sign in with your username and password

Username

Password

[Forgot your password?](#)

**Sign in**

Need an account? [Sign up](#)

Shift to the “Devices” menu and press “Thermostats” (Fig. 41) to view all the registered installations (Fig. 42).

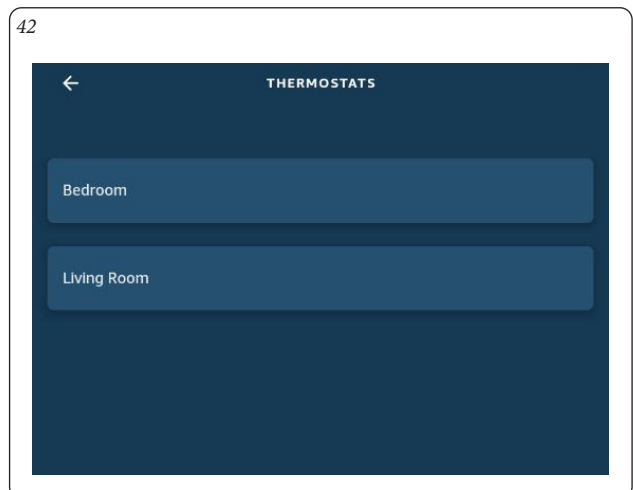
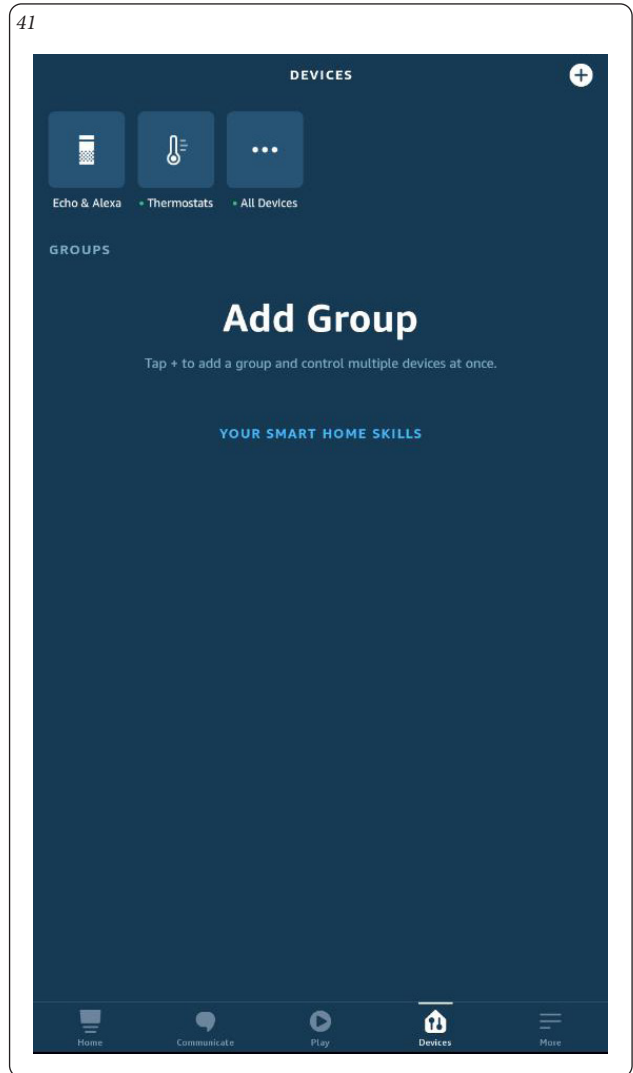

By pressing the desired installation, you may control the temperature directly from Alexa (Fig. 43).

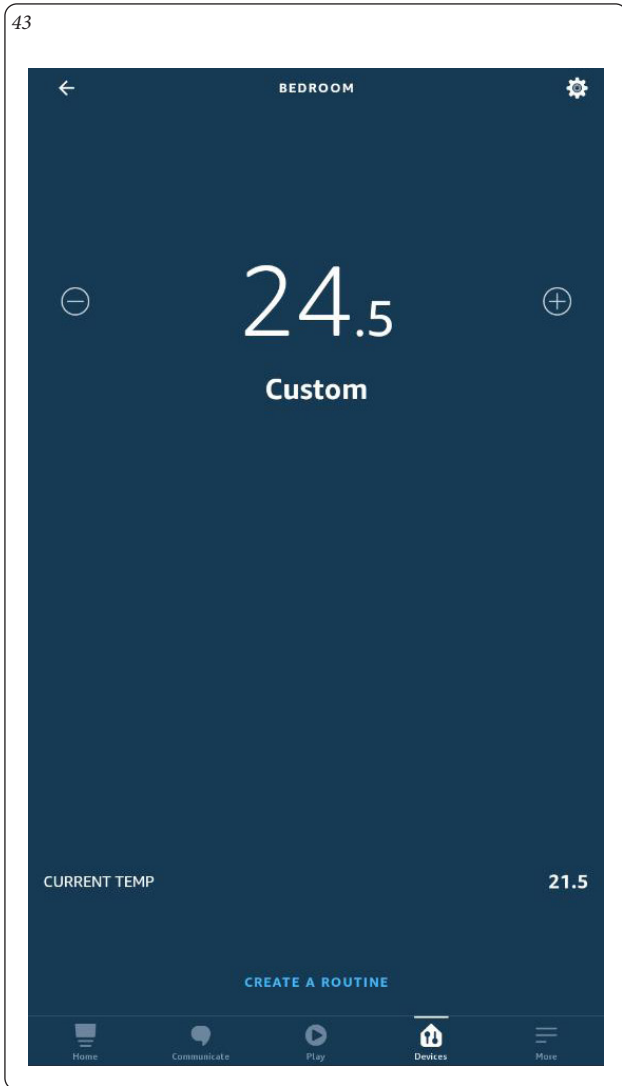

#### 4.2 CONTROL WITH VOICE COMMANDS.

The installations can be controlled with Alexa voice commands.

The following is a brief list of the recognised commands:

- "Alexa check the temperature";
- "Alexa increase the temperature to 22 degrees";
- "Alexa lower the temperature to 20 degrees".

If you have two or more installations, for example Living room and Bedroom, you may specify which thermostat to recall:

- "Alexa, set the temperature of the Living room at 21 degrees."

For the complete list of commands, see the page relative to the Smartech skill on Amazon or Alexa.

## 5 AWAY FUNCTION.

The Away function is used to switch on or off the System based on the GPS position of the Smartphones joined to the System.

### 5.1 FUNCTION DETAILS

- Up to 7 Smartphones can be joined to a single System;
- the Away function can be turned on/off on the individual System;
- if you manually change the temperature from the Chrono-thermostat or from the App, with Away mode on, this mode will be turned off until the next time slot;
- one or more Smartphones can be removed either individually or collectively from the individual system;
- each Smartphone can decide its own range Away;
- each Smartphone can be joined to multiple Systems;
- if the Away function is changed (automatic/manual/off), it will affect all Smartphones joined to the System.

### 5.2 SETTINGS

To open the Away function Settings, select the System to which you want to join the Smartphone (in this case called Living Room) and go to the Settings menu (Fig. 45).

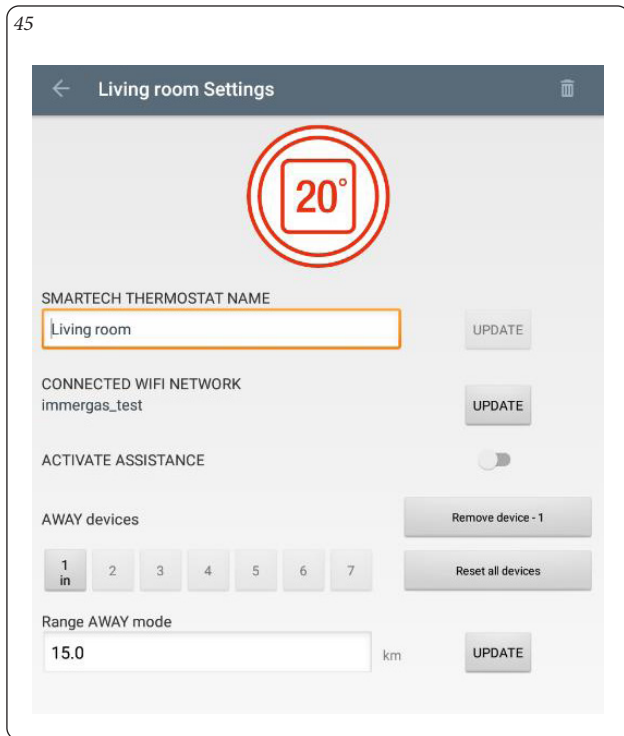

Currently all 7 slots joined to this System are empty, this means that no Smartphone is joined to this System. You can also see that the Range Away is set on 15.0 km.

### 5.3 JOINING A SMARTPHONE

To join a Smartphone to the System, simply press the “JOIN DEVICE” button to fill the first free slot. Next to “JOIN DEVICE” you will see the number joined to the AWAY slot (Fig. 46).

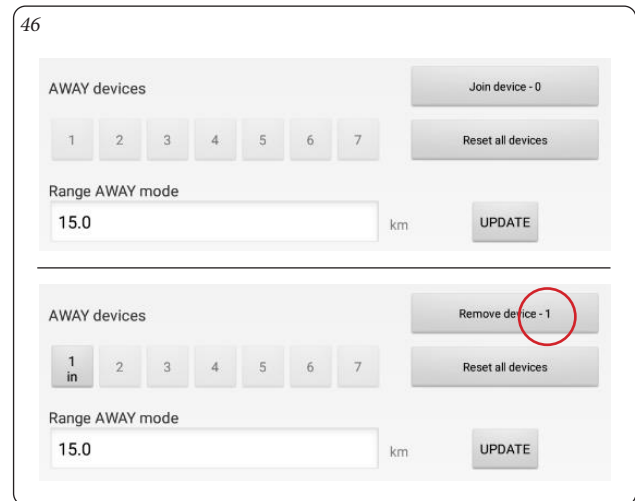

The procedure can be repeated by all Smartphones you wish to join to the System until all available slots have been filled.

### 5.4 REMOVING A SMARTPHONE

To remove a Smartphone from the System, you need to know your Away joining number, in this case the Second one (circled in red), then press your joining number in the System's slots (Fig. 47).

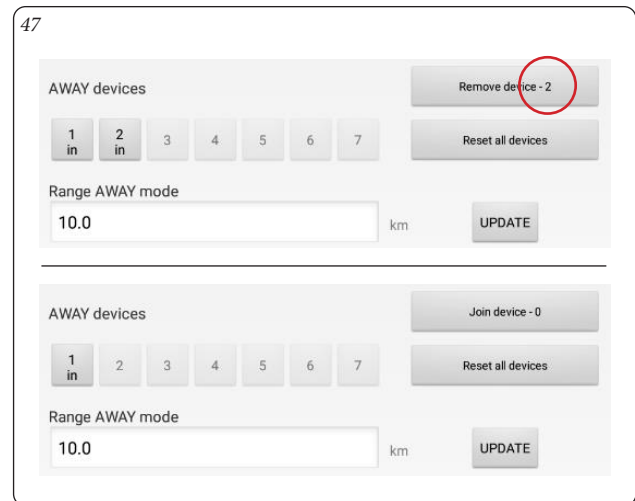

Now the Smartphone is removed from the System.

To remove all the Smartphones joined to the System, simply press “RESET ALL DEVICES” (Fig. 48).

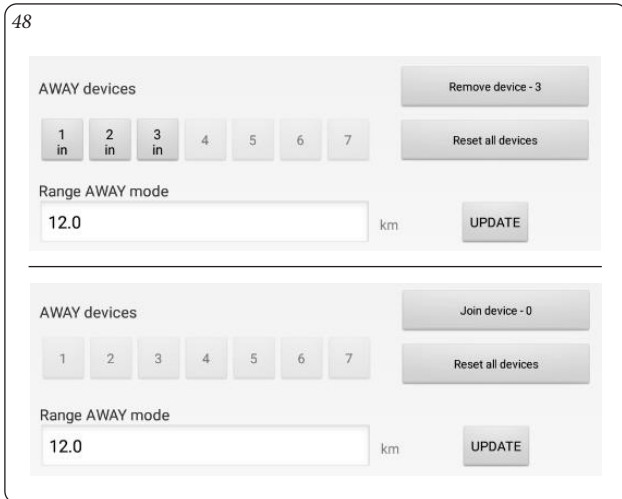

### 5.5 TURNING AWAY MODE ON

Once you have joined your Smartphone to the System as described in (Paragraph 5.3), you can turn on the Away function on the same System.

Pressing the “house” Away button circled in red in the bottom right corner (Fig. 49) on the main screen will open the function options:

- automatic, the mode stays on until it is turned off;
- manual, the mode stays on for a set number of hours;
- Off, the mode is turned off.

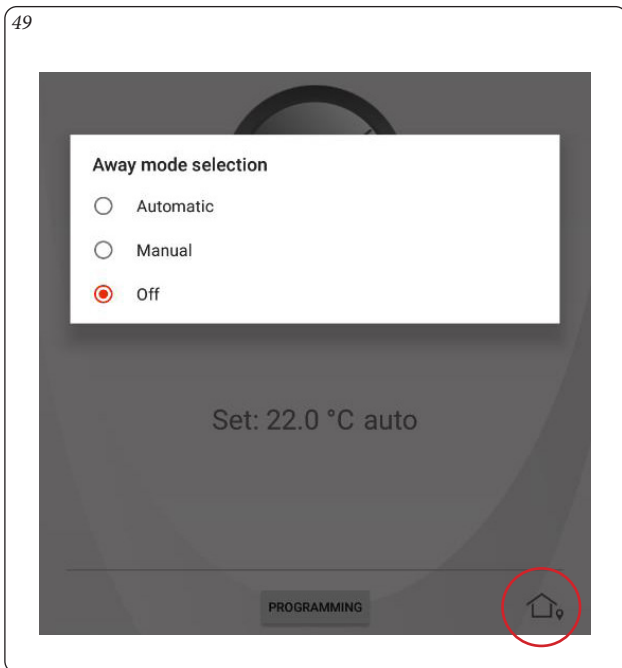

The Away mode is on if the house icon on the main screen is red (Fig. 50).



### 5.6 RANGE AWAY

When the AWAY mode is on, you can check the “range AWAY” of the joined devices (Smartphones) based on their “in” or “out” status as indicated in (Fig. 51).

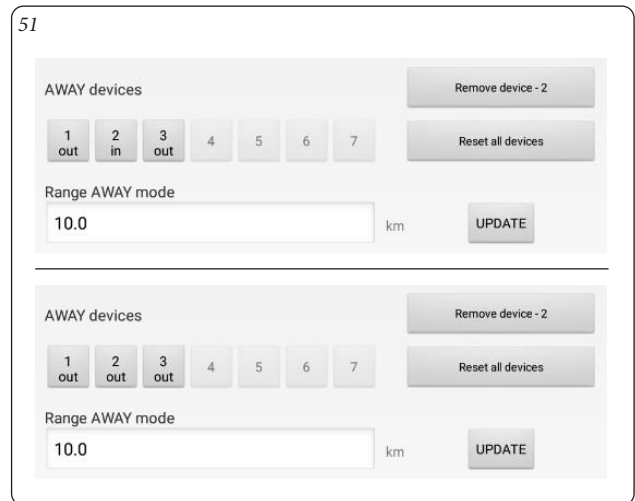

**Note:** all joined devices (Smartphones) must have an “out” status in order to turn the AWAY function on.

To switch from the “in” status to the “out” status, exit the “range AWAY” with your device (Smartphone).

### 5.7 SYSTEM GEOLOCATION CHANGE

The geolocation of the System is linked to the procedure shown in (Paragraph 1.3) in the second **Note**.

Each time you change the password of the Wi-Fi network to which the Gateway is connected or join a new System to the Account, the location is recorded by geolocation of the Smartphone.



This instruction booklet  
is made of ecological paper

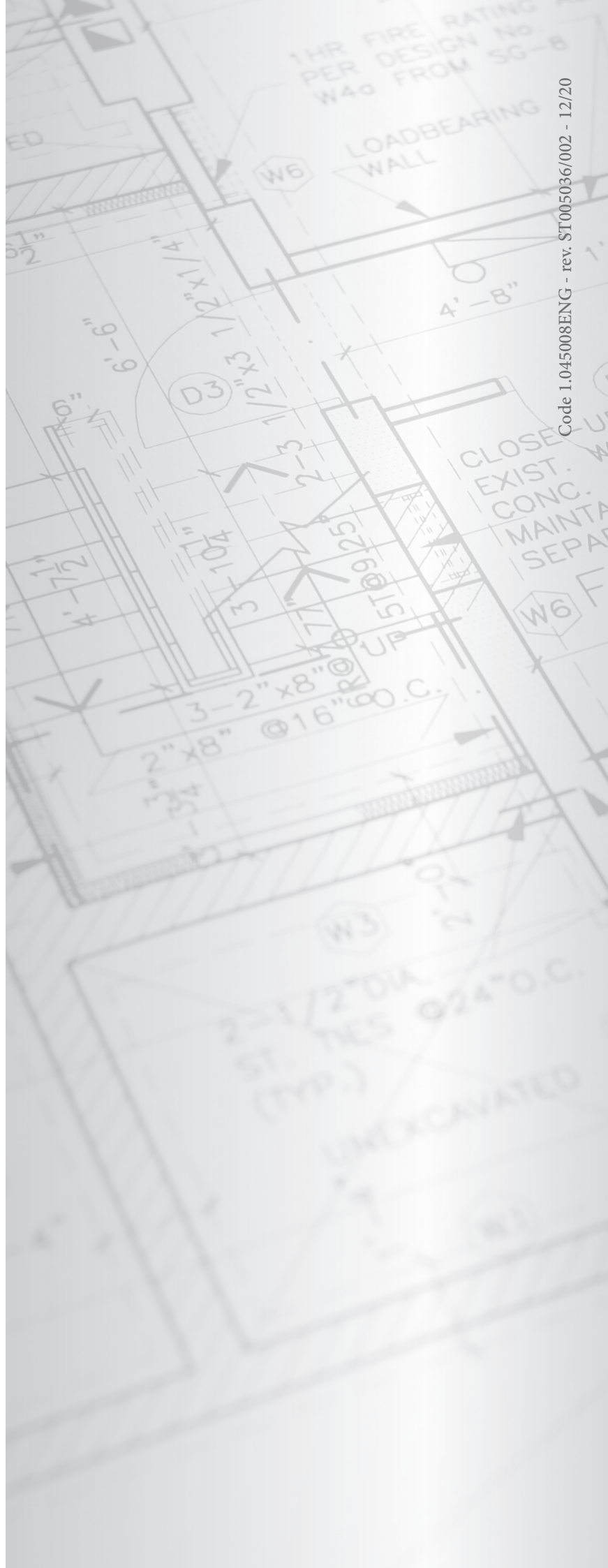

Code 1.045008ENG - rev. ST005036/002 - 12/20



[immergas.com](http://immergas.com)

Immergas S.p.A.  
42041 Brescello (RE) - Italy  
Tel. 0522.689011  
Fax 0522.680617