



Cascade and zone regulator

Zone manager

Thermoregulation for boilers

IE

Instructions and warning book
for the technician



TABLE OF CONTENTS

1	General safety warnings.....	3	7	Summary of parameter setting levels.....	16
1.1	Electrical connection of the regulators.....	3	7.1	Hydraulic section.....	16
1.2	Recommended diameter and length for the cables.....	4	7.2	System section.....	22
2	Zone manager.....	5	7.3	Domestic hot water section.....	25
2.1	Assembly area.....	5	7.4	Configuration direct circuit / mixed circuit 1 / mixed circuit 2.....	27
2.2	Assembly.....	5	7.5	Heat generator level.....	29
2.3	Electrical connection.....	6	7.6	Solar section.....	30
2.4	Assigning bus data addresses.....	6	7.7	Buffer section.....	32
3	Cascade and zone regulator.....	8	7.8	Cascade configuration.....	33
3.1	Assembly of the Cascade and zone regulator.....	8	8	Technical data.....	34
3.2	Electrical installation.....	8	8.1	Cascade and zone regulator.....	34
3.3	Electrical connection to the Cascade and zone regulator.....	9	8.2	Zone manager.....	35
3.4	Start-up of the Cascade and zone regulator.....	10	8.3	Probes resistance values in relation to the temperature.....	36
3.5	Entering the code to change the parameters.....	11	8.4	Product specifications.....	37
3.6	Automatic SET function.....	11			
4	Errors signalling.....	12			
4.1	Malfunction signalling log.....	13			
5	Cascade and zone regulator connection diagram.....	14			
6	Setting the boiler address.....	15			

1 GENERAL SAFETY WARNINGS.

All electrical connections must be carried out by a qualified technician in compliance with the standards and directives in force.

1.1 ELECTRICAL CONNECTION OF THE REGULATORS.

To cut down on electromagnetic compatibility problems, follow the indications provided below:

- Electrical cables and bus data cables must be laid separately, at a minimum distance of 2 cm.
- With cascade and zone regulators equipped with their own connection to the mains, power cables and bus data cables must be laid separately.
- For the assembly of zone managers, a minimum distance of 40 cm must be ensured from other electrical equipment with electromagnetic emissions, such as timers (relays), motors, transformers, luminous regulators, microwave devices, televisions, speakers, computers, mobile phones, etc.

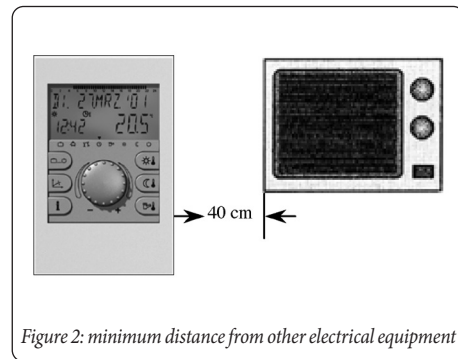
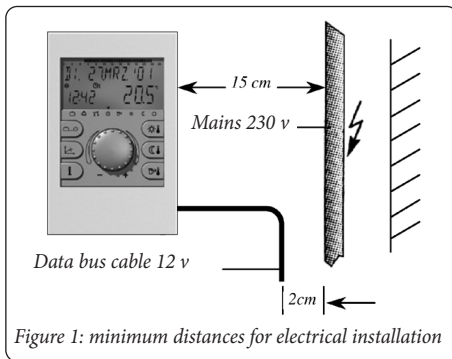

- A minimum distance of 40 cm must be maintained between zone control and cascade regulators. Multiple cascade and zone regulators in data bus connection can be assembled directly one next to the other.

1.2 RECOMMENDED DIAMETER AND LENGTH FOR THE CABLES.

- It is advisable to use shielded cables as data bus conductors.

Recommended types:

J-Y(St)Y 2 x 2 x 0.6

Maximum length: 50 metres.

- The earth connection of the cable shield must be done on one side only. It is prohibited to connect the same cable more than once to the earthing system (see figure 3-4).

- Mains voltage conductor cables $\varnothing = 1.5$ sq.mm.

- Low voltage safety cables (for example, probes) $\varnothing = 0.5$ sq.mm max. length 100 metres.

With data bus star networks, a double earth connection cannot be carried out.

The earth connection has to be carried out on one side of the star only!

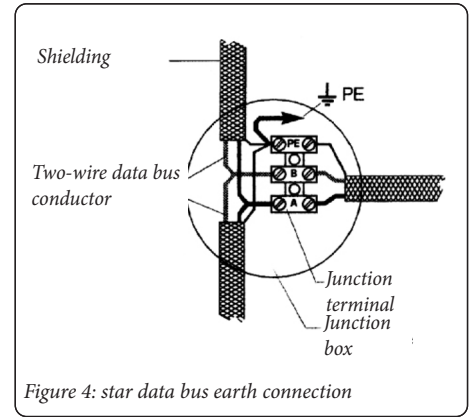
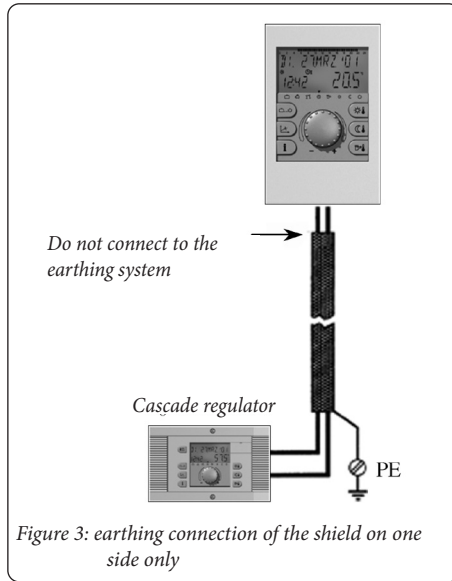

2 ZONE MANAGER.

2.1 ASSEMBLY AREA.

a) use with no room probe.

If the internal room probe is not activated, the device can be assembled anywhere.

b) use with room probe.

If the internal room probe is activated, the device must be positioned at a height of 1.20-1.50 m, and in a place that allows representative measurements for all the other rooms. To this end, an intermediate wall of the coldest room is the ideal location.

The device must not be assembled:

- in places directly hit by sunlight.
- in the vicinity of heat-generating devices, such as televisions, wall-mounted lamps, radiators, etc.
- to walls inside which heating or domestic hot water piping run through.
- on external walls without insulation.
- in corners or recesses, shelves or behind curtains.
- in the vicinity of doors leading to unheated rooms.



Figure 5



Figure 6

2.2 ASSEMBLY.

After having opened the top part, the wall support can be fixed to the walls with the included screws and plugs. The data bus cable must be passed through the bottom opening.

Recommended connection cable:

J-Y(ST)Y 2x0.6

Maximum length: 50 m.

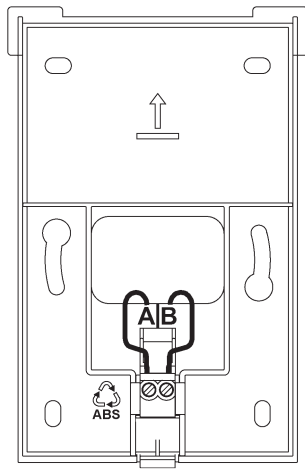

Attention: comply with the polarity during connection of the data bus line (A-B).

Figure 7: Bed (no top part)

2.3 ELECTRICAL CONNECTION.

The double-wire data bus cable is connected to terminals A and B. The connection must be carried out respecting the polarity. By exchanging the two connection cables, no information appears on the display. After having carried out the electrical connection of the Zone manager, reposition it on the support and lower it until you hear a click.

2.4 ASSIGNING BUS DATA ADDRESSES.

The connection of one or more zone managers to the control unit is via a two-wire bus data cable. Since this connection always occurs in parallel in the same cable, data transmission must be selected by means of bus addresses to be assigned.

Bus address (Zone manager). Classification of the bus addresses between the control units and the zone managers is subjected to a strict diagram set by the factory, as indicated in the following table:

Function	Bus address	Zone manager that controls the various rooms	
		Heating circuit	Bus address
Main cascade regulator	10	Direct circuit	11
		Mixed circuit 1	12
		Mixed circuit 2	13
2nd Cascade regulator	20	Direct circuit	21
		Mixed circuit 1	22
		Mixed circuit 2	23
3rd Cascade regulator	30	Direct circuit	31
		Mixed circuit 1	32
		Mixed circuit 2	33
4th Cascade regulator	40	Direct circuit	41
		Mixed circuit 1	42
		Mixed circuit 2	43
5th Cascade regulator	50	Direct circuit	51
		Mixed circuit 1	52
		Mixed circuit 2	53

Entering of bus address in the Zone manager. First start-up.

After having completed the electrical installation and having started up the system, all the available segments appear on the Zone manager display:

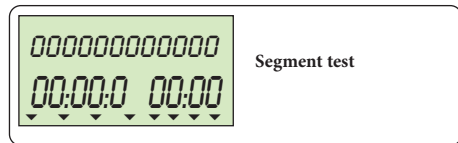

Afterwards, the device identification and bus address are displayed.

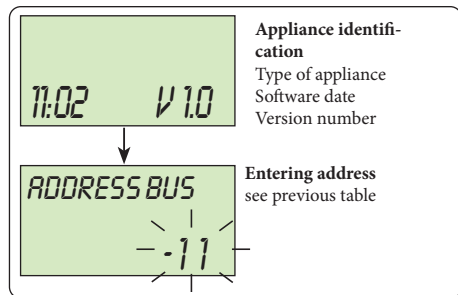

After entering the bus address and confirming it, press the knob to automatically display the classification attributed to the regulator:

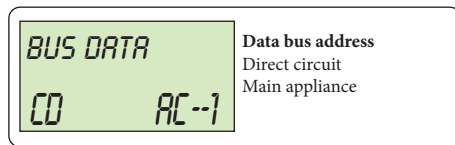

Attention:

If the same bus data address is assigned twice, errors occur during data transmission, consequently resulting in defects in the system adjustments.

- Changing the bus address.

If a bus address must be changed afterwards, proceed as follows:

- 1 Disconnect the bus data cable from the Zone manager.
- 2 Set the Zone manager again by keeping the rotating knob pressed until the bus address is displayed.
- 3 Enter the new bus address and confirm.

3 CASCADE AND ZONE REGULATOR.

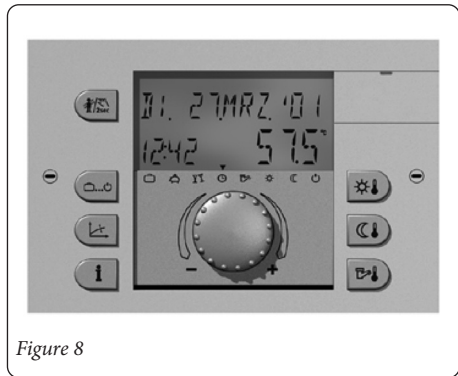

Figure 8

3.1 ASSEMBLY OF THE CASCADE AND ZONE REGULATOR.

All Cascade regulators are designed for flush installation.

Fasten by rotating clockwise the two quick-tightening lateral devices (1).

Reverse operation for disassembly.

3.2 ELECTRICAL INSTALLATION.

The electrical connection and wiring up to the regulating equipment is carried out on the back of the device, in compliance with the diagram shown in Fig. 10.

Current with low safety voltage runs through all connecting terminals inside the field marked in blue (X1); under no circumstances can said terminals come in contact with the mains voltage. Otherwise, the device will be destroyed and the warranty null and void.

The connecting terminals in the fields marked in red (X2....X4) are mains voltage conductors.

Warning:

- When wiring the device, it is imperative to arrange for a **separate** laying of the cables for probes or data bus from the mains voltage conductor cables. Cables for probes and data bus cannot be laid **together** with those that conduct mains voltage, which power the electrical equipment.
- For connection, the special screw connectors (X1÷X4) supplied with the device must be used.

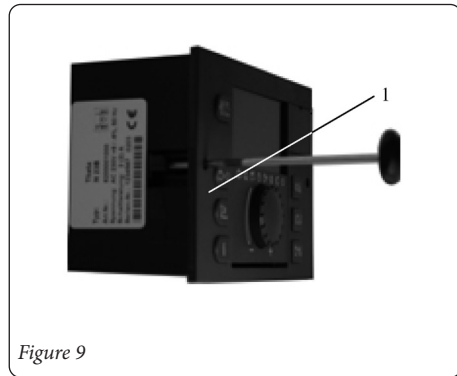
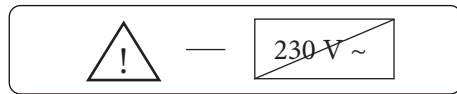

Figure 9



3.3 ELECTRICAL CONNECTION TO THE CASCADE AND ZONE REGULATOR.

Connection to the network.

- 1 Relay output (on / off stage)
- 2 Relay input (on / off stage)
- 3 Direct heating circuit pump (CD)
- 4 N.C.
- 5 Domestic hot water pump
- 6 L 1/ 230 V (power supply)
- 7 Mixed circuit valve (CMI-1) OPEN
- 8 Mixed circuit valve (CMI-1) CLOSED
- 9 Mixed circuit circulation pump 1
- 10 Variable outlet relay 1
- 11 Variable outlet relay 2
- 12 L 1 230/V
- 13 Mixed circuit valve (CMI-2) CLOSED
- 14 Mixed circuit valve (CMI-2) CLOSED
- 15 Mixed circuit circulation pump 2
- 16 N.C.
- 17 Relay outlet (not used)
- 18 Relay input (not used)

- 19 (not used)
- 20 (not used)
- 21 N/230V
- 22 L1 /230V

Low voltage connections.

- 23 Common GND
- 24 Signal data bus connection A (zone controls and room thermostats)
- 25 Signal data bus connection B (zone controls and room thermostats)
- 26 External probe
- 27 generator probe on / off
- 28 Domestic hot water probe
- 29 Mixed circuit flow probe 1 (PTC)
- 30 Variable input 1
- 31 Variable input 2
- 32 Variable input 3
- 33 Mixed circuit flow probe 2 (PTC)
- 34 Solar panel probe
- 35 Solar boiler probe
- 36 Pulse input

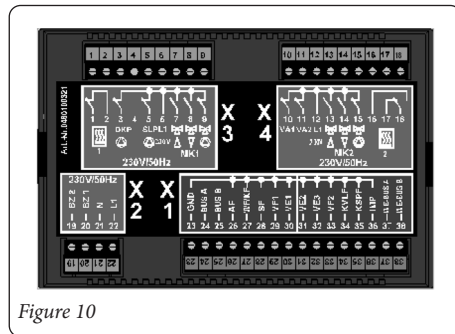

Figure 10

- 37 Boiler data bus A
- 38 Boiler data bus B

Bus address (Cascade manager). If there is only one regulating unit, it is always assigned bus address 10. When there are multiple connected regulating units (maximum of 5), the regulator that is connected directly to the boiler must be assigned address 10. The other regulators must be assigned addresses with progressive numbers, such as 20, 30, 40 and 50.

3.4 START-UP OF THE CASCADE AND ZONE REGULATOR.

Identification and segments test.

When the device is turned on for the first time or when power is restored, all the available segments are temporarily shown on the display:

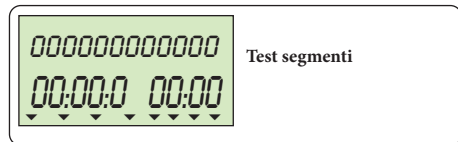

Afterwards, the device model is displayed along with the type code and software version number.

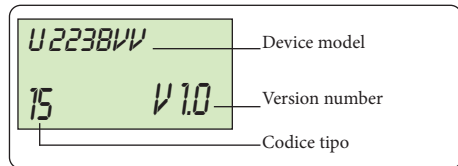

If no errors have been signalled, the basic display appears with date, time and current temperature of the heat generator.

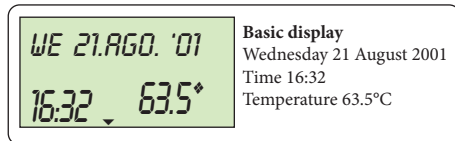

Summertime operation is indicated by the symbol of a beach umbrella (☂).

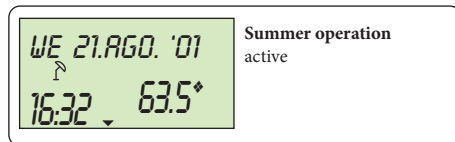

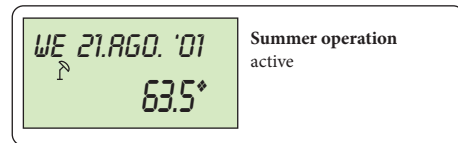

An active anti-freeze protection function is indicated by the symbol of an ice flake (❄).



3.5 ENTERING THE CODE TO CHANGE THE PARAMETERS.

Technician's code. After the technician's code is entered, his/her parameters are activated so that they can be changed depending on the system characteristics.

Entering the code. To enter the technician's code, press buttons  and  simultaneously for about 3 seconds until the display indicates CODICE [CODE]

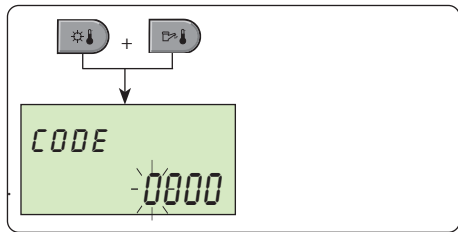

Turn the knob to enter the code number in the flashing section; the number is then saved by pressing the knob.

NOTE: This code is provided upon request by the IM-MERGAS technical assistance department.

If the code has been properly entered, the message INSTALLATORE OK [INSTALLER OK] appears on the display. In case of incorrect code, the message CODICE ERRATO [WRONG CODE] is displayed.

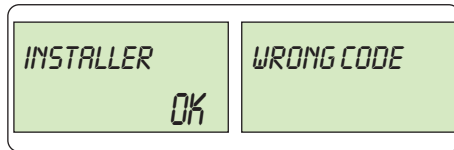

Attention: if no operation is carried out for ten seconds, the code needs to be re-entered.

Once the code has been entered, all the parameters listed in the tables (chapter 6) can be changed.

The following menus are also available in addition to the ones described in the user operating booklet:

- **IDRAULICA [HYDRAULICS]:** for settings pertaining to the installed circuit;
- **GENERATORE [GENERATOR]:** to configure the boiler type;
- **SOLARE [SOLAR]:** to configure the regulation of a

solar panel, if installed;

- **CASCATA [CASCADE]:** to adjust the parameters for battery-powered operation;
- **BUFFER:** to configure the regulation of a buffer storage tank;
- **BUS DATI [DATA BUS]:** to enter the BUS address;
- **TEST RELAIS [RELAY TEST]:** to manually activate the regulator relays;
- **DIFETTI DI FUNZIONAMENTO [OPERATIONAL DEFECTS]:** to display the operational malfunctions;
- **OFFSET SONDA [PROBE OFFSET]:** to correct the readings of the temperature probes.

3.6 AUTOMATIC SET FUNCTION.

With this function, the presence of the heating and domestic hot water circuits whose probes are connected to the regulator can be configured in automatic.

The AUTO - SET function is activated when the device is turned on and stays active for 24 hours.

If a configuration was stored during the first start-up, this configuration can only be changed with the manual activation of the AUTO - SET function. This activation is achieved by cutting off power and then restoring it, keeping the knob pressed.

4 ERRORS SIGNALLING.

Any errors are always signalled by the Cascade and zones regulator and then stored.

There are five different error categories:

1 Signalling of probe errors. Any resistance values of the probes falling outside the measuring range are considered a failure. They are indicated, depending on the use, with failure codes 10...20 and, depending on the nature of the failure, with index 0 for short circuit or 1 for interruption.

2 Signalling of control logic errors. These evaluate the outcome expected from the adjustments. Depending on the model and on the classification, they are indicated with failure codes 50...60 and index 0, 1 or 2.

3 Signalling of bus errors. These failure signals refer to address errors such as duplicates or failure to recognize addresses within the bus data. Depending on the model and on the classification, they are indicated with failure codes 70 and index 0 or 1.

4 Signalling of boiler board errors. These error signals come from the boiler board and are divided into manual reset blocks with failure codes En-XX (see boiler booklet) or temporary stop (release with electrical reset) with failure codes Bn-XX (see boiler booklet).

Error management:

- failures are signalled in the basic regulator display.
- system failures appear in the information level with the relevant value.
- if necessary, failures are written down in the error log (see description below).
- by duly setting the parameters, the failures activate an error signalling output for connection of a visual or acoustic warning device.

Error signalling tables:

Probes and variable inputs:

Designation	Kind of defect	Code
External probe	Shut-off	10-0
External probe	Short circuit	10-1
Boiler probe	Shut-off	11-0
Boiler probe	Short circuit	11-1
Flow probe 1	Shut-off	12-0
Flow probe 1	Short circuit	12-1
Domestic hot water probe	Shut-off	13-0
Domestic hot water probe	Short circuit	13-1

Designation	Kind of defect	Code
EV 2	Shut-off	14-0
EV 2	Short circuit	14-1
EV 2	Error signalling	14-7
EV 3	Shut-off	15-0
EV 3	Short circuit	15-1
EV 3	Error signalling	15-7
EV 1	Shut-off	16-0
EV 1	Short circuit	16-1
EV 1	Error signalling	16-7
Manifold storage tank probe	Shut-off	17-0
Manifold storage tank probe	Short circuit	17-1
Flow probe 2	Shut-off	18-0
Flow probe 2	Short circuit	18-1
Manifold flow probe	Shut-off	19-0
Manifold flow probe	Short circuit	19-1
Burner 1	not OFF	30-2
Burner 1	not ON	30-3
Burner 2	not OFF	31-2
Burner 2	not ON	31-3

Designation	Kind of defect	Code
Thermal hour meter	no impulse	32-3
Flue temperature	Exceeded	33-5
Flue temperature	TE.SIC. data bus operation	33-8
Heat generator temperature	not reached (after 90 minutes)	S0-4
Temperature of domestic hot water	not reached (after 4 hours)	S1-4
Temperature of flow CMI1	not reached (after 1 hour)	S2-4
Temperature of flow CMI2	not reached (after 1 hour)	S3-4
Temperature of room CD	not reached (after 3 hours)	S4-4
Temperature of room CMI1	not reached (after 3 hours)	S5-4
Temperature of room CMI2	not reached (after 3 hours)	S6-4
Activity	addresses collision	70-0
Activity	No T2B	70-1
Activity	No i2C	70-3

Designation	Kind of defect	Code
Activity	No connection to the heat generator bus	70-6
Activity	Master missing	70-8
Impulse input failure	No signal	90-0

Boiler error:

Designation	Kind of defect	Code
Error	block* (with manual reset)	En-XX
Error	block* (with electrical reset)	Bn-XX

* see boiler instructions booklet

4.1 MALFUNCTION SIGNALLING LOG.

The basic regulator unit is equipped with an error signalling log in which a maximum of 5 warnings can be stored. Error warnings are displayed in the operating defects menu along with date, time and nature of the error. By accessing this code-protected menu, the latest error warning is displayed; rotate the knob to display all 5 latest error warnings.

5 CASCADE AND ZONE REGULATOR CONNECTION DIAGRAM.

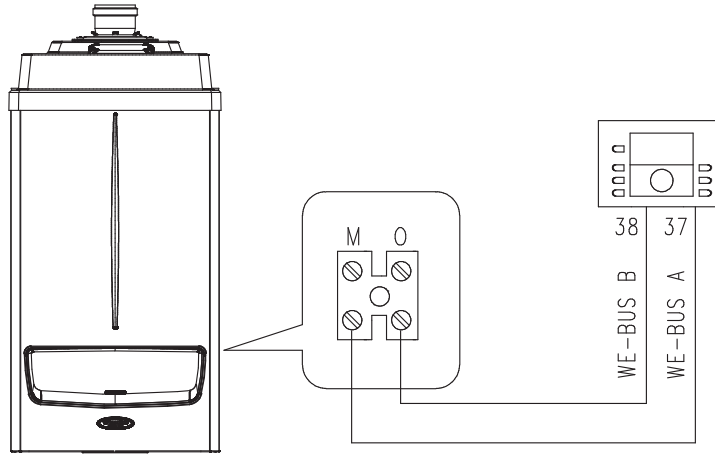

Figure 11

6 SETTING THE BOILER ADDRESS.

Once the electrical connection has been carried out, the address needs to be set on the communication board (4) of each single boiler by setting the address according to the following indications.

Open the boiler control panel (1) (ensuring that power to the boiler has been disconnected first), by unscrewing screws (3) and opening the cover (2);
Remove the communication board (4), by pressing on the clip to release it from its seat.

The switches (5) used to set the boiler addresses are on the opposite side (Fig. 12).

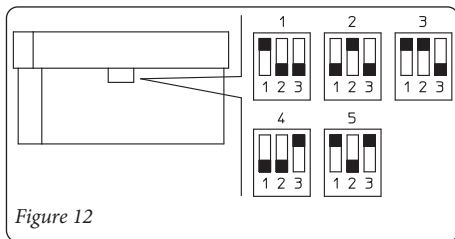

Figure 12

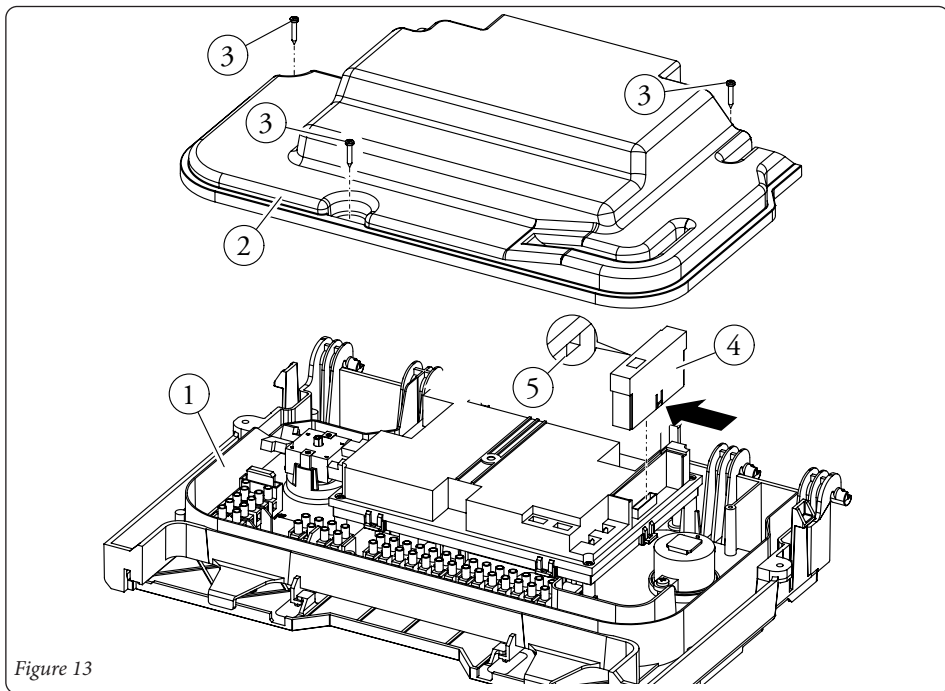

Figure 13

7 SUMMARY OF PARAMETER SETTING LEVELS.

Press the rotary knob for 3 seconds. Select the desired level with the rotary knob and confirm. The displayed parameters are different depending on the set automation level (user or technician).

N.B.: Some parameters may be missing depending on the setting of the cascade and zone regulator and its software version.

7.1 HYDRAULIC SECTION.

PARAMETER	Description	Factory setting	Adjustment field / Parameters
02	Domestic hot water pump output function assignment	1	OFF No function 1 Domestic hot water supply pump 4 Recirculation pump 5 Electrical heating
03	Mixed circuit 1 output function assignment	3	OFF No function 2 Direct circuit dependent on atmospheric conditions 3 Mixer circuit dependent on atmospheric conditions 6 Constant value regulator 7 Fixed value regulator 8 Return increase 40 Constant regulator cooling

PARAMETER	Description	Factory setting	Adjustment field / Parameters
04	Mixed circuit 2 output assignment	3	OFF No function 2 Direct circuit dependent on atmospheric conditions 3 Mixer circuit dependent on atmospheric conditions 6 Constant value regulator 7 Fixed value regulator 8 Return increase 40 Constant regulator cooling
05	Direct circuit pump output function assignment	2	OFF No function 2 Direct circuit pump 4 Recirculation pump 5 Electrical heating bar 6 Constant adjustment 10 Boiler supply pump 11 Boiler circuit pump 1 12 Boiler circuit pump 2 13 General malfunction 14 Timer 15 Solar pump (type ..VV.) 21 Request in parallel to the generator 27 Buffer storage tank unloading 41 HC heating / cooling commutation

PARAMETER	Description	Factory setting	Adjustment field / Parameters
06/07	Variable outputs 1 - 2 function assignment	OFF	OFF No function 4 Recirculation pump 5 Electrical heating bar 9 Return pump 10 Boiler supply pump 11 Boiler circuit pump 1 12 Boiler circuit pump 2 13 General malfunction signalling 15 Solar supply pump 16 Buffer storage tank supply pump 17 Solid fuel supply pump 19 Solar storage tank commutation valve 20 Forced solar dissipation 21 Request in parallel to the generator 26 Priority pump 27 Buffer storage tank unloading 41 HK heating / cooling commutation

PARAMETER	Description	Factory setting	Adjustment field / Parameters
08	Variable input 1 - 3 assignment	OFF	OFF No function 1 External probe 2 2 Heat generator probe 2 3 Storage tank probe 2 4 Buffer probe 2 5 Request contact 6 Malfunction signalling external input 7 Return probe (SR1) 8 Return probe (SR2) 9 Return probe (SR) 10 Heat generator external block 11 External modem activation 12 External information 13 Manifold total flow probe 14 Solar manifold return probe 16 Flue probe 18 Solid fuel buffer probe 19 Buffer probe 1

PARAMETER	Description	Factory setting	Adjustment field / Parameters
09	Variable input 2 assignment	OFF	OFF No function 1 External probe 2 2 Heat generator probe 2 3 Storage tank probe 2 4 Buffer probe 2 5 Request contact 6 Malfunction signalling external input 7 Return probe (SR1) 8 Return probe (SR2) 9 Return probe (SR) 10 Heat generator external block 11 External modem activation 12 External information 13 Manifold total flow probe 14 Solar manifold return probe 18 Solid fuel buffer probe 19 Buffer probe 1

PARAMETER	Description	Factory setting	Adjustment field / Parameters
10	Variable input 3 assignment	OFF	OFF No function 1 External probe 2 2 Heat generator probe 2 3 Storage tank probe 2 4 Buffer probe 2 5 Request contact 6 Malfunction signalling external input 7 Return probe (SR1) 8 Return probe (SR2) 9 Return probe (SR) 10 Heat generator external block 11 External modem activation 12 External information 13 Manifold total flow probe 14 Solar manifold return probe 18 Solid fuel buffer probe 19 Buffer probe 1
11	Indirect increase of return temperature	OFF	OFF, ON

7.2 SYSTEM SECTION.

PARAMETER	Description	Factory setting	Adjustment field / Parameters
LANGUAGE	Selection of language used	EN	BG Bulgarian / DE German / GB English / FR French / IT Italian / NL Dutch / ES Spanish / PT Portuguese / HU Hungarian / CZ Czech / PL Polish / RO Romanian / RU Russian / TR Turkish / SE Swedish / NE Norwegian
TIME PROGRAMME	Number of operation time programmes activated	P1	P1 Only one timer programme enabled P1-P3 Three timer programmes enabled
UTILISATION MODE	Activation of separate utilisation mode	1	1 Common adjustment of all heating circuits 2 Separate adjustment of individual heating circuits
SUMMER	Summer temperature turn-off limit	20°C	OFF deactivated System anti-freeze protection +30°C
05	Anti-freeze temperature (external probe)	0°C	OFF deactivated -20 summer deactivation
06	Assignment of heating circuit for request contact on VE 1	1	1 Direct circuit 2 Mixer circuit 1 3 Mixer circuit 2 4 Domestic hot water TUTT [ALL] All circuits
07	Contact module for request for VE-2	1	1 Direct circuit 2 Mixer circuit 1 3 Mixer circuit 2 4 Domestic hot water TUTT [ALL] All circuits

PARAMETER	Description	Factory setting	Adjustment field / Parameters
08	Contact module for request for VE-3	1	1 Direct circuit 2 Mixer circuit 1 3 Mixer circuit 2 4 Domestic hot water TUTT [ALL] All circuits
09	Reference climate area	5°C	-20...0°C
10	Type of building	2	1 light construction 2 average construction 3 heavy construction
11	Automatic output time	2 Min.	Off disabled 0.5 ... 5 Min.
12	Forced operation of pumps and anti-block mixing valves	ON	ON activated OFF deactivated
13	Error logic signalling	OFF	OFF no display ON display activated
14	Automatic SET function	OFF	OFF probe automatic identification deactivated ON probe automatic identification activated
19	Anti-freeze protection mode	OFF	OFF Anti-freeze protection constant according to the value set in parameter 05 - system anti-freeze protection 0.5 ... 50 min.
23	User level block code	OFF	OFF (0000) block deactivated ON (0001 ... 9999) block activated

PARAMETER	Description	Factory setting	Adjustment field / Parameters
24	Temperature display in Faraday	OFF	OFF display in °C and K ON display in °F
27	Management of automatic burner failure signalling system	OFF	1 Data visualized on display only 2 Error message in the system 3 Error messages and block in the system 4 Error messages, block and signalling in the system
28	Failure messages memory 2	OFF	OFF, ON
RESET	Factory calibration		In relation to the access code, to activated parameters only

7.3 DOMESTIC HOT WATER SECTION.

PARAMETER	Description	Factory setting	Adjustment field / Parameters
NIGHT DOMESTIC HOT WATER	Reduced temperature for domestic hot water	40°C	5°C ... Domestic hot water maximum temperature
ANTI-LEGIONELLA DAY	Domestic hot water anti-legionella function (day)	OFF	OFF No anti-legionella function Mon...Sun Anti-legionella function on the specified day All Anti-legionella function all days of the week
03	Domestic hot water anti-legionella function (hour)	02:00	00:00...23:00
04	Domestic hot water anti-legionella function (temperature)	65°C	10°C ... Domestic hot water maximum temperature
05	Domestic hot water temperature detection type	1	1 Domestic hot water temperature probe 2 Domestic hot water thermostat
06	Domestic hot water temperature maximum limit	65°C	20°C ... heat generator maximum temperature
07	Domestic hot water operating mode	2	1 Parallel operation 2 Priority operation 3 Conditional priority operation 4 Parallel operation dependent upon atmospheric conditions 5 Priority operation with intermediate heating 6 Activation of separate priority operation 7 External operation
08	Domestic hot water drain protection	ON	OFF - anti-drain deactivated ON - anti-drain activated
09	Increase in loading temperature of domestic hot water	15 K	0 ... 50 K;

PARAMETER	Description	Factory setting	Adjustment field / Parameters
10	Domestic hot water ignition thermostat hysteresis	5 K	2 ... 20 K
11	Domestic hot water post-circulation	5 Min.	0 ... 60 Min.
12	Recirculation pump timer	AUTO	AUTO Domestic hot water times programme active 1 P1, direct heating circuit 2 P2, direct heating circuit 3 P3, direct heating circuit 4 P1, mixed heating circuit 1 5 P2, mixed heating circuit 1 6 P3, mixed heating circuit 1 7 P1, mixed heating circuit 2 8 P2, mixed heating circuit 2 9 P3, mixed heating circuit 2 10 P1, domestic hot water circuit 11 P2, domestic hot water circuit 12 P3, domestic hot water circuit
13	Recirculation pump pause interval	5 Min.	0 Min ... value parameter 14
14	Recirculation pump cycle duration	20 Min.	1 .. 60 Min. (pause + period duration)

7.4 CONFIGURATION DIRECT CIRCUIT / MIXED CIRCUIT 1 / MIXED CIRCUIT 2.

These sections contain all the parameters needed to programme the direct or mixed heating circuits.

PARAMETER	Description	Factory setting	Adjustment field / Parameters
REDUCED	Type of operation reduced/eco	ECO	ECO operation with stop RID [RED] operation with reduced temperature
COMF SYSTEM	Heating system, climatic curve	CD = 1-30 CMI = 1.10	1.00 ... 10.00
03	Room probe activation	OFF	OFF Room sensor deactivated 1 Room sensor activated 2 Room sensor active, blocked command 3 Display only (room temperature)
04	Room probe weight on flow temperature	OFF	OFF 10 ... 500% weight RC peripheral regulator active
05	Climatic curve automatic adaptation	OFF	OFF, ON
06	Early heating ignition	OFF	OFF 1 ... 16 h
07	Heating limitation (winter)	OFF	OFF 0.5 ... 40 K
08	Room anti-freeze temperature	10°C	5 ... 30°C
09	Room thermostat function activation	OFF	OFF 0.5 ... 5 K (differential)

PARAMETER	Description	Factory setting	Adjustment field / Parameters
10	Adjustment based on outdoor temperature (only if VE n = AF 2)	0	0 Command based on the average value AF 1 + AF 2 1 Command based on AF 1 2 Command based on AF 2
11	Constant temperature desired value	20°C	7 ... 105°C
12	Minimum heating temperature	20°C	5°C ... HK _{max}
13	Heating maximum temperature	75°C	From minimum heating temperature to maximum heating temperature
14	Generator / circuit temperature increase	CD = 0 CMI = 4	-5 ... 20 K
15	Heating circuit post-circulation	5 Min.	0 ... 60 Min.
16	Screed heating function	OFF	OFF Function disabled 1 Heating operation 2 Operation with set profile 3 Heating + set profile operation
25	Holidays operational mode	STBY	STBY, RID [RED]
50	Cooling, activation point, AT	OFF	OFF 15 ... 45°C
51	Cooling, maximum point, AT	35°C	15 ... 45°C
52	Cooling, VL nominal temperature heating circuit with activation point	18°C	7 ... 30°C

PARAMETER	Description	Factory setting	Adjustment field / Parameters
53	Cooling, VL nominal temperature heating circuit with maximum point	24°C	7 ... 30°C
54	Cooling, room nominal temperature heating circuit with activation point	23°C	15 ... 30°C
55	Cooling, room nominal temperature heating circuit with maximum point	28°C	15 ... 30°C
56	Minimum cooling temperature (bottom limit)	18°C	7 ... 24°C

7.5 HEAT GENERATOR LEVEL.

PARAMETER	Description	Factory setting	Adjustment field / Parameters
01	Generator type	1	OFF Without heat generator 1 Gas / single-stage diesel oil 4 Variable burner 5 Condensation burners
02	Generator start protection N.B.: only with parameter 01 different from condensation	1	OFF Anti-start function deactivated 1 Anti-start function on minimum 2 Anti-start function controlled by atmospheric conditions 3 Separate anti-start function
03	Generator minimum temperature	38°C	5°C ... Maximum temperature limit

PARAMETER	Description	Factory setting	Adjustment field / Parameters
04	Generator maximum temperature limit	80°C	Adjustment field: Parameter 03 ... Maximum limit
26	Calculated flow temperature increase (only for cascade operation)	10 K	0 ... 60 K
27	Heating circuits minimum temperature limitation	36°C	5°C ... KT_{\min} (only with reduced load start - parameter 02 = 3)
28	Heating circuits temperature minimum limit operation field	4 K	2 K ... 20 K (only with separate exhaust - Parameter 02 = 3)
29	Forced generator exhaust	OFF	OFF Deactivated function 1 Deviation in domestic hot water storage tank 2 Deviation in heating circuits 3 Deviation in buffer storage tank

7.6 SOLAR SECTION.

PARAMETER	Description	Factory setting	Adjustment field / Parameters
01	ΔT Solar pump activation	10 K	(deactivation difference + 3 K) ... 30 K
02	ΔT Solar pump deactivation	5 K	2 K ... (activation field - 3 K)
03	Solar pump operation minimum duration	3 Min.	0 ... 60 Min.
04	Solar collector maximum temperature	120°C	Adjustment field: 70 ... 210°C
05	Solar storage tank maximum temperature	75°C	20 ... 110°C

PARAMETER	Description	Factory setting	Adjustment field / Parameters
06	Solar operation mode	2	1 Priority operation 2 Parallel operation 3 Hot water operation 4 Buffer storage tank priority operation
07	Heat generator alternating block	OFF	OFF 0.5 ... 24 h (only with priority operation - parameter 06 = 1, 3, 4)
08	In parallel / solar priority commutation	OFF	OFF 1 ... 30 K (only with priority operation and alternating block active)
09	Solar heating balance	OFF	OFF No heating balance 1 Heating balance with flow rate calculation 2 Heating balance through impulse input
SOLAR RESET	Heating balance reset	-	Reset press the knob on SET (Only with solar heating balance active)
11	Flow rate	0.0 l / min	0.0 ... 30 l/min or l / impulse (only with solar heating balance active)
12	Average density	1.05 kg / l	0.8 ... 1.2 kg / l (Only with solar heating balance active)
13	Average specific heating capacity	3.6 kJ / KgK	2.0 ... 5.0 KJ / KgK (Only with solar heating balance active)

7.7 BUFFER SECTION.

PARAMETER	Description	Factory setting	Adjustment field / Parameters
01	Minimum temperature	20°C	5°C ... Maximum temperature
02	Maximum temperature	80°C	Storage tank minimum temperature ... 95°C
03	Boiler temperature increase compared to the Set value	8 K	-10 ... 80 K
04	Hysteresis OFF	2 K	1 ... 70 K
05	Forced deviation for heat dissipation	OFF	OFF 1 Deviation in domestic hot water storage tank 2 Deviation in heating circuits
06	Hysteresis ON post-circulation	10 K	(Deactivation difference + 2 K) ... 30 K
07	Hysteresis OFF post-circulation	50 K	OFF (Commutation difference + 2 K) ... 50 K
08	Start protection	ON	OFF Anti-start function deactivated ON Anti-start function active
09	Drain protection	ON	OFF Anti-exhaust function deactivated ON Anti-exhaust function active
10	Storage tank operation mode	1	1 Domestic hot water and heating circuit supply adjustment 2 Adjustment of heating circuit supply with no domestic hot water 3 Domestic hot water and heating circuit drain adjustment 4 Adjustment of heating circuit drain with no domestic hot water 5 Adjustment of supply with domestic hot water commutation 6 Adjustment of drain to heat generator

PARAMETER	Description	Factory setting	Adjustment field / Parameters
11	Storage tank load pump post-circulation	0 min.	0 ... 60 Min.

7.8 CASCADE CONFIGURATION.

PARAMETER	Description	Factory setting	Adjustment field / Parameters
01	Common flow differential	8 K	0.5 ... 30.0 K
02	Start delay	0 Min.	0 ... 200 Min.
03	Switch-off delay	0 Min.	0 ... 60 Min.
04	Boilers switch-on power	65 %	10 ... 100 %
05	Boilers sequence reversal	OFF	OFF 1 ... 240 h
06	Sequence master	1	1 ... n stage
07	Boiler peak load from address	OFF	OFF 2 ... (max. stages) numbering of all heat generators connected in cascade mode
08	Basic load commutation in the grouping	OFF	OFF Commutation deactivated ON Commutation activated
09	Domestic hot water quick switch-on	OFF	OFF 1 ... maximum number of stages

8 TECHNICAL DATA.

8.1 CASCADE AND ZONE REGULATOR.

Power supply voltage:	230 V~ +6/-10%
Rated frequency:	50 - 60 Hz
Power absorption:	max. 5.8 VA
Bus interface:	T2B 12V/150 mA
Room temperature:	0...50°C
Warehouse temperature:	-25...60°C
Type of protection:	IP 30
Protection rating according to EN 60730:	II
Protection rating according to EN 60529:	III
Software class:	A
Electromagnetic emission:	EN 55014 (1993)
Immunity:	EN 55104 (1995)
Compliance with directive:	2004/108/EC
Container dimensions (LxHxD):	Basic regulator: 144 x 96 x 75 mm
Container material:	ABS with antistatic
Rated current:	6 A
Device fuse:	6.3 A
Output relay contact maximum load:	2 A

8.2 ZONE MANAGER.

Supply voltage:	through data bus (low safety voltage according to EN 60730)
Power absorbed:	300 mW
Bus interface:	T2B
Room temperature:	0...50°C
Warehouse temperature:	-25...60°C
Protection rating according to EN 60529:	IP 20
Protection rating according to EN 60730:	III
Verified according to:	EN 60 730
Container dimensions:	90 x 138 x 28 mm (LxHxD)
Container material:	ABS with antistatic
Data storage and timer autonomy: min. 5 years	
Accuracy of internal clock:	± 2 s/day
Display:	alphanumeric screen with symbols
Weight:	about 150 g

8.3 PROBES RESISTANCE VALUES IN RELATION TO THE TEMPERATURE.

Type: kty 2K Ω at 25°C

T (°C)	R (k Ω)
10	1.783
12	1.812
14	1.840
16	1.869
18	1.898
20	1.928
25	2.002
30	2.078
35	2.155
40	2.234
45	2.314
50	2.395
55	2.478
60	2.563
65	2.648
70	2.735
75	2.824
80	2.914
85	3.005
90	3.098
95	3.192
100	3.287

8.4 PRODUCT SPECIFICATIONS.

In accordance with Regulation 811/2013 the temperature control device class is:

Class	Contribution to the environmental heating seasonal energy efficiency	Description
VI	+4%	Administrator kit
VIII	+5%	Administrator kit coupled to 3 environment sensors

Follow us

Immergas Italia



immergas.com

Immergas S.p.A.
42041 Brescello (RE) - Italy
Tel. 0522.689011
Fax 0522.680617

Certified company ISO 9001

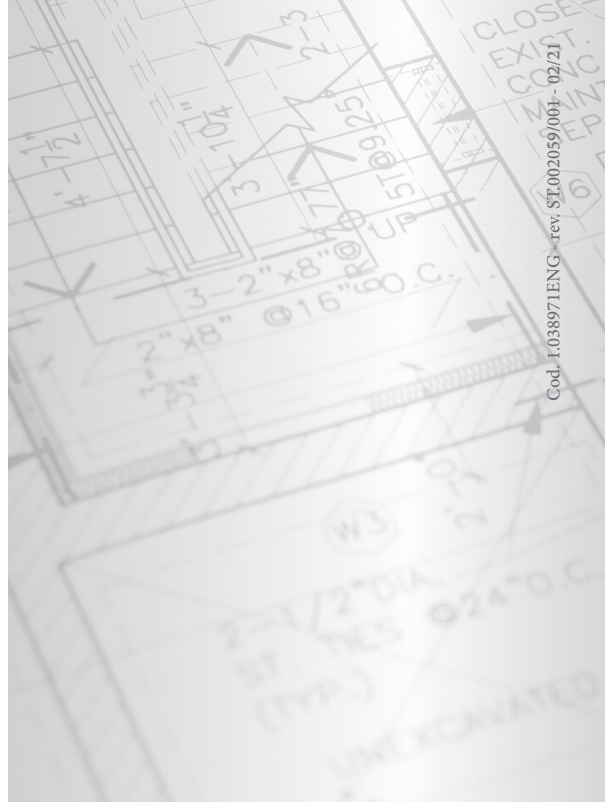

Cod. I.038971ENG - rev. ST.002059/001 - 02/21